

**SUPER**OFFERTA 2017



€ Senza IVA 58/2017



# GIRA E RIGIRA

## IL NOSTRO DURA DI PIÙ



**NUOVO CRICCHETTO 237 A.**  
L'UNICO CERTIFICATO IP51  
RESISTENTE ALLA POLVERE  
E ALL' USURA.

La SuperOfferta diventa semestrale - valida fino al 31/08/2017

EDIZIONE 1

**NEW**



**Cricchetti  
e set bussole**

**PAG  
3**

**NEW**



**Chiavi  
di manovra**

**PAG  
12**



**Chiavi  
maschio**

**PAG  
16**



**Giraviti**

**PAG  
18**



**Inserti**

**PAG  
22**

**NEW**



**Serraggio  
controllato**

**PAG  
25**



**Pinze**

**PAG  
28**



**Isolati 1000V**

**PAG  
31**

**NEW**



**Elettrotecnica**

**PAG  
32**

**NEW**



**Idraulica**

**PAG  
36**



**Estrattori**

**PAG  
40**



**Illuminazione**

**PAG  
42**

**NEW**



**Utensili  
pneumatici**

**PAG  
44**

**NEW**



**Tool box**

**PAG  
48**



**Borse e valigie**

**PAG  
50**



**Banchi da  
lavoro**

**PAG  
56**

**NEW**



**Assortimenti**

**PAG  
58**



**Carrelli**

**PAG  
62**



**Scarpe da  
lavoro**

**PAG  
67**



**Autoriparazione**

**PAG  
68**

## 237 A

### CRICCHETTO REVERSIBILE CON MECCANISMO SIGILLATO IP51



NELLO STABILIMENTO DI GEMONIO ABBIAMO PROGETTATO E REALIZZATO IL NUOVO CRICCHETTO 237 A PER DURARE PIÙ A LUNGO DI QUALSIASI ALTRO CRICCHETTO MAI ESISTITO SUL MERCATO.

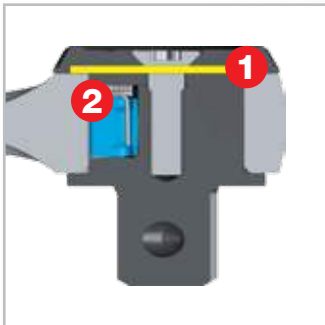

1. Diaframma protettivo  
2. Nottolino brevettato



Sistema di inversione integrato nel coperchio



Spessore della testa ridotto rispetto ai modelli standard

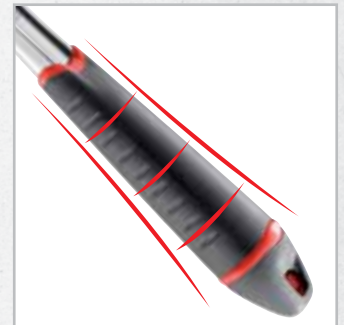

Impugnatura conica in bimatrimiale e antiscivolo



**NEW**

**237 A 1/4"**  
Cod. U02370102

**72**  
DENTI

**Cricchetto reversibile 1/4"**

€ 30,00 **€ 21,00**



**NEW**

**237 A 3/8"**  
Cod. U02370104

**72**  
DENTI

**Cricchetto reversibile 3/8"**

€ 35,00 **€ 24,50**



**NEW**

**237 A 1/2"**  
Cod. U02370106

**72**  
DENTI

**Cricchetto reversibile 1/2"**

€ 40,00 **€ 28,00**

## NUOVE CASSETTE MODULARI IN ABS



**RESISTENTI  
AGLI URTI**



**CHIUSURA  
RAPIDA**



**DIMENSIONI  
COMPATTE**



**TAGLIA  
L**

**TAGLIA  
M**

**TAGLIA  
S**

**I MODULI INTERNI POSSONO ESSERE ESTRATTI ED UTILIZZATI  
ALL'INTERNO DEI CASSETTI DI TUTTI I CARRELLI USAG**





## 606 1/4 EA

Cod. U06060101

17  
PEZZI

### Assortimento in cassetta di ABS con bussole esagonali

- Cassetta in ABS ad alta resistenza con sistema di chiusura rapida
- Il modulo interno è studiato per essere modulare con i cassettei dei carrelli

~~€ 95,80~~ € 62,00

DESCRIZIONE	ART./MISURA	PZ.
Chiavi a bussola con bocca esagonale	235 1/4 EN 4-5-5,5-6-7-8-9-10-11-12-13-14	12
Prolunga	236 1/4 50	1
Cricchetto reversibile certificato IP51	237 A 1/4	1
Leva a T con attacco scorrevole	240 1/4	1
Snodo cardanico	241 1/4	1
Portabussole con impugnatura	243 1/4	1

1 Kg L. 210  
H. 60  
P. 130

**NEW**



## 606 1/2 EA

Cod. U06060302

23  
PEZZI

### Assortimento in cassetta di ABS con bussole esagonali

- Cassetta in ABS ad alta resistenza con sistema di chiusura rapida
- Il modulo interno è studiato per essere modulare con i cassettei dei carrelli

~~€ 200,93~~ € 120,00

DESCRIZIONE	ART./MISURA	PZ.
Chiavi a bussola con bocca esagonale	235 1/2 EN 8-9-10-11-12-13-14-15-16-17-18-19-21-22-23-24-27-30-32	19
Prolunghe	236 1/2 125-250	2
Snodo cardanico	241 1/2	1
Cricchetto reversibile certificato IP51	237 A 1/2	1

3 Kg L. 330  
H. 60  
P. 215

**NEW**



## 606 1/2 A

Cod. U06060301

23  
PEZZI

### Assortimento in cassetta di ABS con bussole poligonali

- Cassetta in ABS ad alta resistenza con sistema di chiusura rapida
- Il modulo interno è studiato per essere modulare con i cassettei dei carrelli

~~€ 199,79~~ € 120,00

DESCRIZIONE	ART./MISURA	PZ.
Chiavi a bussola con bocca poligonale	235 1/2 N 8-9-10-11-12-13-14-15-16-17-18-19-21-22-23-24-27-30-32	19
Prolunghe	236 1/2 125-250	2
Snodo cardanico	241 1/2	1
Cricchetto reversibile certificato IP51	237 A 1/2	1

3 Kg L. 330  
H. 60  
P. 215

**NEW**

# SET BUSSOLE



**NEW**

**Kg** 4,5 Kg L. 435  
H. 70  
P. 270



**607 1/2 EA**

Cod. U06070302



**30**  
PEZZI

**Assortimento in cassetta di ABS con bussole esagonali**

~~€ 277,34~~ **€ 180,00**

**607 1/2 A**

Cod. U06070301



**30**  
PEZZI

**Assortimento in cassetta di ABS con bussole poligonali**

- Cassetta in ABS ad alta resistenza con sistema di chiusura rapida
- Il modulo interno è studiato per essere modulare con i cassettei dei carrelli

~~€ 276,20~~ **€ 180,00**

DESCRIZIONE	ART./MISURA	PZ.
Chiavi a bussola con bocca esagonale (Poligonale)	235 1/2 EN 8-9-10-11-12-13-14-15-16-17-18-19-20-21-22-23-24-26-27-28-29-30-32-34	24
Prolunghe	236 1/2 125-250	2
Manovella con impugnatura girevole	239 1/2 N	1
Leva a T con attacco quadro scorrevole	240 1/2 N	1
Snodo cardanico	241 1/2	1
Cricchetto reversibile certificato IP51	237 A 1/2	1



**NEW**

**Kg** 1,5 Kg L. 435  
H. 70  
P. 270



**606 3/8 EA**

Cod. U06060202



**21**  
PEZZI

**Assortimento in cassetta di ABS con bussole esagonali**

~~€ 169,24~~ **€ 100,00**

**606 3/8 A**

Cod. U06060201



**21**  
PEZZI

**Assortimento in cassetta di ABS con bussole poligonali**

- Cassetta in ABS ad alta resistenza con sistema di chiusura rapida
- Il modulo interno è studiato per essere modulare con i cassettei dei carrelli

~~€ 169,08~~ **€ 100,00**

DESCRIZIONE	ART./MISURA	PZ.
Chiavi a bussola con bocca esagonale (poligonale)	235 3/8 E 6-7-8-9-10-11-12-13-14-15-16-17-18-19-21-22	16
Prolunghe	236 3/8 125-250	2
Cricchetto reversibile certificato IP51	237 A 3/8	1
Leva a T con attacco quadro scorrevole	240 3/8 N	1
Snodo cardanico	241 3/8	1



## 606 1/4 EAK

Cod. U06060103



**17**  
PEZZI

### Assortimento in cassetta di ABS con bussole esagonali

- Cassetta in ABS ad alta resistenza con sistema di chiusura rapida
- Il modulo interno è studiato per essere modulare con i cassettei dei carrelli

~~€ 109,30~~

**€ 76,50**

1 Kg L. 210  
H. 60  
P. 130

**NEW**

DESCRIZIONE	ART./MISURA	PZ.
Chiavi a bussola con bocca esagonale	235 1/4 EN 4-5-5,5-6-7-8-9-10-11-12-13-14	12
Prolunga	236 1/4 50	1
Cricchetto con impugnatura rotante	237 AK 1/4	1
Leva a T con attacco scorrevole	240 1/4	1
Snodo cardanico	241 1/4	1
Portabussole con impugnatura	243 1/4	1



## 604 1/2 EAK

Cod. U06040305



**15**  
PEZZI

### Assortimento in cassetta di ABS con bussole esagonali

- Cassetta in ABS ad alta resistenza con sistema di chiusura rapida
- Il modulo interno è studiato per essere modulare con i cassettei dei carrelli

~~€ 155,71~~

**€ 109,00**

2 Kg L. 330  
H. 60  
P. 215

**NEW**

DESCRIZIONE	ART./MISURA	PZ.
Chiavi a bussola con bocca esagonale	235 1/2 EN 10-11-12-13-14-15-16-17-18-19-21-22-24	13
Prolunga	236 1/2 125	1
Cricchetto con impugnatura rotante	237 AK 1/2	1



## 605 3/4" EB

Cod. U06050212



**120**  
DENTI

**18**  
PEZZI

## 605 3/4" B

Cod. U06050211



**120**  
DENTI

**18**  
PEZZI

### Assortimento con bussole esagonali o poligonali

- Cassetta in ABS
- Clip di aggancio in metallo

~~€ 520,15~~

**€ 364,00**

15 Kg L. 415  
H. 100  
P. 565

DESCRIZIONE	ART./MISURA	PZ.
Bussole esagonali (poligonali)	235 3/4 E(N) 19-21-22-24-27-30-32-34-36-41-46-50-55	13
Prolunghe	236 3/4" 200-400	2
Leva a T con attacco Quadro scorrevole	240 3/4 N	1
Snodo cardanico	241 3/4	1
Cricchetto reversibile	237 B 3/4	1

# SET BUSSOLE



**601 1/4-1/2 J100**

Cod. U06018011M

**100**  
PEZZI

Assortimento in cassetta modulare  
con bussole esagonali ed inserti per avvitatura

8 Kg L. 415  
H. 92  
P. 283

€ 156,00

**€ 109,00**

Just **USAG**



Just **USAG** ti regala

**SVITOL**

**COMPRESSE NEL PREZZO CON OGNI CASSETTA:**

**x1**  
Svitol Lubrificante  
multiuso  
400 ml



**x1**  
Svitol Grasso  
lubrificante  
ad alte prestazioni PTFE  
400 ml

Scopri il mondo  
Svitol su:  
[www.svitol.it](http://www.svitol.it)



DESCRIZIONE	MISURA	PZ.
Chiavi a bussola 1/4" con bocca esagonale	4-4,5-5,5-6-7-8-9-10-11-12-13-14 mm	12
Chiavi a bussola 1/4" lunghe con bocca esagonale	6-8-10-11-12-13-14 mm	7
Chiavi a bussola 1/4" con bocca TORX®	E6-E8-E10	3
Chiavi a bussola 1/4" con inserto a croce PH	1-2	2
Chiavi a bussola 1/4" con inserto a croce PZ	1-2	2
Chiavi a bussola 1/4" con inserto ad intaglio	0,6x4-1,2x7	2
Chiavi a bussola 1/4" con inserto esagonale maschio	3-4-5-6	4
Chiavi a bussola 1/4" con inserto TORX®	T8-T10-T15-T20-T25-T27-T30	7
Prolunghe 1/4"	50-100 mm	2
Snodo cardanico 1/4"		1
Leva a T 1/4"		1
Impugnatura porta-bussole 1/4"		1
Cricchetto reversibile 1/4"		1

DESCRIZIONE	MISURA	PZ.
Chiavi a bussola 1/2" con bocca esagonale	10-11-12-13-14-15-16-17-18-19-20-21-22-24-27-30-32 mm	17
Chiavi a bussola 1/2" lunghe con bocca esagonale	13-14-15-17-19-22 mm	6
Chiavi a bussola 1/2" con bocca TORX®	E12-E14-E16-E18-E20-E24	6
Chiavi a bussola 1/2" per candele	16-21 mm	2
Prolunghe 1/2"	130-250 mm	2
Snodo cardanico 1/2"		1
Cricchetto reversibile 1/2"		1
Riduttore	1/2"-3/8"	1
Chiave a bussola portainseriti	1/2"-5/16"	1
Inserti 5/16" ad intaglio	8-12	2
Inserti 5/16" a croce PH	3-4	2
Inserti 5/16" a croce PZ	3-4	2
Inserti 5/16" TORX®	T40-T45-T50-T55	4
Inserti 5/16" esagonali maschio	8-10-12-14 mm	4
Inserti 5/16" XZN	6-8-10-12	4





1/4"



1/2"

8÷22 mm



	7 Kg		L. 415 H. 92 P. 283
--	------	--	---------------------------

**601 1/4-1/2 J82**  
Cod. U06018010M

**82**  
PEZZI

**Assortimento in cassetta modulare  
con bussole esagonali e chiavi combinate**

Just **USAG**

~~€ 254,52~~ **€ 171,00**



Just **USAG** ti regala **SVITOL**

**COMPRESSE NEL PREZZO CON OGNI CASSETTA:**

**x1**  
Svitol Lubrificante  
multiuso  
400 ml



**x1**  
Svitol Grasso  
lubrificante  
ad alte prestazioni PTFE  
400 ml

Scopri il mondo  
Svitol su:  
[www.svitol.it](http://www.svitol.it)



DESCRIZIONE	MISURA	PZ.
Chiavi combinate	8-10-11-12-13-14-17-19-22 mm	9
Chiavi a bussola 1/4" con bocca esagonale	4-4,5-5-5,5-6-7-8-9-10-11-12-13-14 mm	13
Prolunghe 1/4"	55-100 mm	2
Prolunga flessibile	150 mm	1
Cricchetto reversibile 1/4"		1
Impugnatura porta-bussole 1/4"		1
Snodo cardanico 1/4"		1
Leva a T 1/4"		1
Bussola portainseri	1/4"-1/4"	1
Chiavi a bussola 1/4" con inserto ad intaglio	4-5,5-7	3
Chiavi a bussola 1/4" con inserto a croce PH	1-2	2
Chiavi a bussola 1/4" con inserto a croce PZ	1-2	2
Chiavi a bussola 1/4" con inserto esagonale maschio	3-4-5-6	4

DESCRIZIONE	MISURA	PZ.
Chiavi a bussola 1/4" con inserto TORX®	T8-T10-T15-T20-T25-T30	6
Chiavi a bussola 1/2" con bocca esagonale	14-15-16-17-18-19-20-22-24-27-30-32 mm	12
Chiavi a bussola 1/2" per candele	16-21 mm	2
Prolunghe 1/2"	130-250 mm	2
Cricchetto reversibile 1/2"		1
Snodo cardanico 1/2"		1
Bussola porta inserti	1/2"-5/16"	1
Riduttore	1/2"-3/8"	1
Inserti 1/4" ad intaglio	8-10-12	3
Inserti 1/4" a croce PH	3-4	2
Inserti 1/4" a croce PZ	3-4	2
Inserti 1/4" esagonali maschio	8-10-12-14 mm	4
Inserti 1/4" TORX®	T40-T45-T50-T55	4



**Kg** 1 Kg **mm** L. 190  
H. 58  
P. 138

## 601 1/4 J34

Cod. U06010001

**34**  
PEZZI

**Assortimento in cassetta modulare con bussole esagonali ed inserti per avvitatura**

~~€ 69,00~~ **€ 44,50**

DESCRIZIONE	MISURA	PZ.
Chiavi a bussola 1/4"	4-4,5-5-5,5-6-7-8-9-10-11-12-13-14	13
Cricchetto reversibile 1/4"		1
Snodo cardanico 1/4"		1
Prolunghe 1/4"	55-100	2
Inserti a intaglio	4-5,5-6	3
Inserti a croce Pozidriv®	1-2-3	3
Inserti esagono maschio	4-5-6	3
Inserti TORX®	10-15-20-25-20-40	6
Impugnatura maschio/femmina		1
Raccordo portainseriti 1/4"		1



**Kg** 4 Kg **mm** L. 372  
H. 80  
P. 186

## 601 1/2 J22

Cod. U06010003

**22**  
PEZZI

**Assortimento in cassetta modulare con bussole esagonali**

~~€ 101,00~~ **€ 65,00**

DESCRIZIONE	MISURA	PZ.
Bussole esagonali 1/2"	8-10-11-12-13-14-15-16-17-18-19-21-22-24-27-30-32	17
Cricchetto 1/2"		1
Prolunghe 1/2"	130-250	2
Snodo cardanico 1/2"		1
Leva a T 1/2"		1



**Kg** 1 Kg **mm** L. 190  
H. 58  
P. 138

## 601 1/4-1/2 JTX16

Cod. U06010009



**16**  
PEZZI

**Assortimento in cassetta modulare con bussole TORX®**

~~€ 36,00~~ **€ 25,00**

DESCRIZIONE	MISURA	PZ.
Chiavi a bussola 1/4 TORX®	E6-E7-E8-E10	4
Chiavi a bussola 1/2 TORX®	E12-E14-E16-E18	4
Chiavi a bussola 1/4 con inserto TORX®	T10-T15-T20-T25	4
Chiavi a bussola 1/2 con inserto TORX®	T30-T40-T45-T50	4

**NEW**



**002 JM**

Cod. U00028003M

**181**  
PEZZI

**Valigia con assortimento per manutenzione**

- Valigia con struttura in profilato di Alluminio e rinforzi in metallo
- Doppia cerniera di chiusura in metallo con serratura
- Maniglia con protezione in materiale plastico
- 3 pannelli portautensili interni con elastici di tenuta
- Sistema di bloccaggio del pannello basculante
- Base con interno in mousse bicolore sagomata

~~€ 533,46~~

**€ 359,00**



**Kg** 11 Kg    **mm** L. 460  
H. 155  
P. 370

**BULLONI  
TREMATE**

Just **USAG** ti regala **SVITOL**

**COMPRESSE NEL PREZZO CON OGNI CASSETTA:**

**x2**  
**Svitol Lubrificante  
multiuso**  
**400 ml**



**x2**  
**Svitol Grasso  
lubrificante  
ad alte prestazioni PTFE**  
**400 ml**

Scopri il mondo  
Svitol su:  
[www.svitol.it](http://www.svitol.it)



DESCRIZIONE	MISURA	PZ.
Chiavi a bussola 1/2" con bocca esagonale	10-11-12-13-14-15-16-17-18-19-21-22-24-27-30-32 mm	16
Chiavi a bussola 1/4" con bocca esagonale	4-4,5-5-5,5-6-7-8-9-10-11-12-13-14 mm	13
Prolunghe 1/2"	130-250 mm	2
Prolunghe 1/4"	55-100 mm	2
Cricchetto reversibile 1/2"		1
Cricchetto reversibile 1/4"		1
Impugnatura porta bussole 1/4"		1
Snodo cardanico 1/2"		1
Snodo cardanico 1/4"		1
Bussola portainseriti	1/4-1/4"	1
Chiavi combinate	8-9-10-11-12-13-14-15-16-17-18-19 mm	12
Chiave a rullino	250 mm	1
Giraviti ad intaglio	0,4x2,5-0,6x3,5-0,8x4-1x5,5-1,2x6,5-1,6x8	6
Giraviti a croce PH	1-2	2
Giraviti a croce PZ	1-2	2
Chiavi maschio esagonali	1,5-2-2,5-3-4-5-6-8-10 mm	9
Pinza universale	180 mm	1
Pinza regolabile	240 mm	1
Pinza a becchi mezzotondi	160 mm	1
Tronchese a taglio diagonale	160 mm	1
Giravite cercafase		1

DESCRIZIONE	MISURA	PZ.
Forbice da elettricista		1
Cutter multiuso		1
Flessometro	5 m	1
Mini seghetto		1
Martello da meccanico	300 gr	1
Inseriti ad intaglio	3-4-4,5-5-5,5-6-6,5-7-8	9
Inseriti a croce PH	00-0-1(x2)-2(x2)-3-4	8
Inseriti a croce PZ	1-2(x2)-3-4	5
Inseriti esagonali maschio	1,5-2-2,5-3-4-5-5,5-6-7-8 mm	10
Inseriti esagonali maschio	1/16-5/64-3/32-7/64-1/8-9/64-5/32-3/16-7/32-1/4	10
Inseriti Torx	T8-T9-T10-T15-T20-T25-T27-T30-T40-T45	10
Inseriti Torx Tamper Resistant	T8-T10-T15-T20-T25-T27-T30-T35-T45	9
Inseriti Tri-Wing	1-2-3-4	4
Inseriti Spanner	4-6-8-10-12	5
Inseriti Torq-set	6/8/10	3
Inseriti quadrati	0-1-2(x2)-3	5
Inseriti Clutch	1/8-5/32-3/16-1/4-5/16	5
Inseriti XZN	M5-M6-M8	3
Inseriti esagonali maschio con foro	2-2,5-3-4-5-6	6
Inseriti esagonali maschio con foro	5/64-3/32-7/64-1/8-9/64-5/32	6
Prolunghe magnetiche	1/4"	2

## 285 KA

### CHIAVE COMBINATA A CRICCHETTO CON ANELLO DI TENUTA

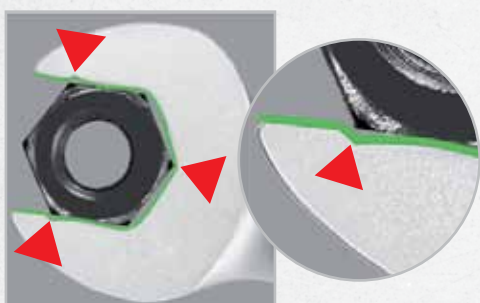

**FORCHETTA CON SISTEMA  
ANTISLITTAMENTO**  
dell'esagono durante la manovra



**ANELLO IN ACCIAIO ARMONICO**  
integrato nell'occhio poligonale per  
posizionarsi sul dado durante la manovra



**NEW**

**285 KA/DS8**  
Cod. U02856058

**8**  
PEZZI

Serie di 8 chiavi a cricchetto  
• 285 KA/8-10-11-12-13-14-17-19 mm

~~€ 136,70~~

**€ 89,00**

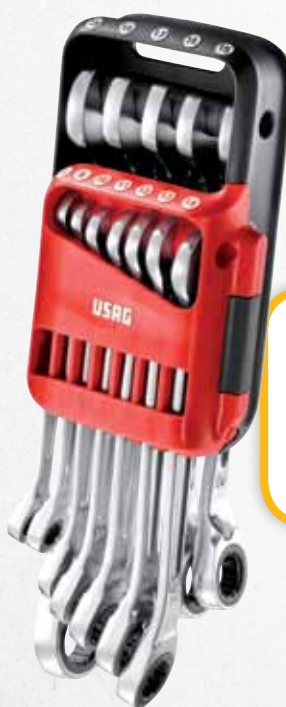

**NEW**

**285 KA/DS12**  
Cod. U02856062

**12**  
PEZZI

Serie di 12 chiavi a cricchetto  
• 285 KA/7-8-10-11-12-13-14-15-16-  
17-18-19 mm

~~€ 208,20~~

**€ 146,00**

**285 KB**

**CHIAVE COMBINATA A CRICCHETTO PIATTA**



**TESTA A CRICCHETTO PIATTA**  
per favorire l'accessibilità in punti  
difficili da raggiungere



**CAMBIO DEL SENSO DI ROTAZIONE**  
ribaltando la chiave di 180°



**NEW**

**285 KB/B10**  
Cod. U02856340

**10**  
PEZZI

**Serie di 10 chiavi combinate a cricchetto piatte**  
• 285 KB/8-10-12-13-14-15-16-17-18-19 mm

~~€ 131,66~~

**€ 89,00**

UNI 6733  
DIN 3114



**248 SE7**

Cod. U02480200

**Serie di 7 chiavi a forchetta semplici**

- 10-13-17-19-24-30-32 mm

**16**  
PEZZI

~~€ 79,00~~

**€ 55,30**

**NEW**

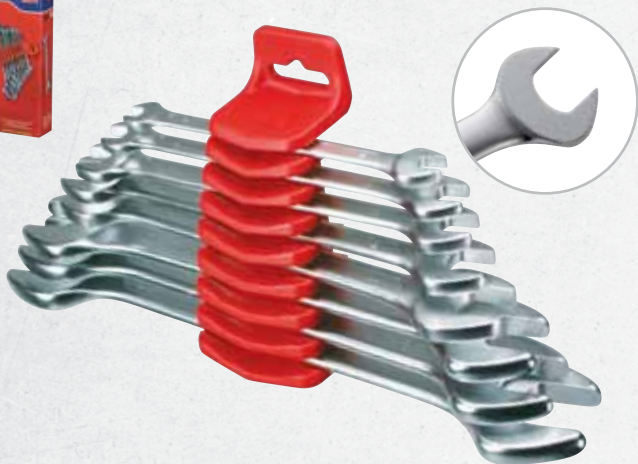

**252 N/SR8**

Cod. U02520862

**Serie di 8 chiavi a forchetta doppie**

- 252 N/6x7-8x9-10x11-12x13-14x15-16x17-18x19-20x22 mm
- Fornita con supporto in plastica

**8**  
PEZZI

~~€ 48,70~~

**€ 34,00**



**276 CE/SE8**

Cod. U02760484

**Serie di 8 chiavi a T snodate**

- 276 CE/7-8-10-12-13-14-17-19 mm

**8**  
PEZZI

~~€ 220,80~~

**€ 155,00**



**ISO 6787  
DIN 3117  
ASME B107.100**

**294 AC**  
Cod. U02940010

MAX  
**34**  
mm

**Chiave regolabile a rullino corta**

- Leggera e compatta
- Regolazione con rullino in acciaio
- Scala millimetrata sulla testa della chiave
- Finitura cromata



~~€ 19,80~~ **€ 14,00**



0÷34  
mm

Apertura ganasce pari ad una chiave a rullino da 2"



5,4  
mm

Spessore ganasce ridotto per una migliore accessibilità



**285 DE/S9**  
Cod. U02850857

**9**  
PEZZI

**Serie di 9 chiavi combinate**

- 285/8-10-11-12-13-14-15-17-19 mm
- Fornita in supporto in plastica

~~€ 76,50~~ **€ 49,00**



**285 SE26**  
Cod. U02850861

**26**  
PEZZI

**Serie di 26 chiavi combinate**

- 285/6-7-8-9-10-11-12-13-14-15-16-17-18-19-20-21-22-23-24-25-26-27-28-29-30-32 mm

~~€ 301,92~~ **€ 211,00**



## 280 LTS/S9

Cod. U02800084



9  
PEZZI

### Serie di 9 chiavi maschio esagonale lunghe testa sferica

- 280 LTS/1,5-2-2,5-3-4-5-6-8-10 mm
- Esecuzione brunita
- Supporto in plastica

~~€ 28,00~~

**€ 17,50**



Estrazione della singola chiave senza muovere le altre



## 280 LTSTX/S8

Cod. U02800078



8  
PEZZI

### Serie di 8 chiavi maschio lunghe testa sferica TORX®

- 280 LTSTX/T10-T15-T20-T25-T27-T30-T40-T45
- Esecuzione brunita
- Supporto in plastica

~~€ 50,50~~

**€ 35,00**



Estrazione della singola chiave senza muovere le altre

**MODELLO EXTRA LUNGO  
+30% RISPETTO ALLE 280 LTS**

## 280 L/S9

Cod. U02800057



9  
PEZZI

### Serie di 9 chiavi maschio esagonale lunghe

- 280 L/1,5-2-2,5-3-4-5-6-8-10 mm
- Esecuzione brunita
- Supporto in plastica

~~€ 19,90~~

**€ 14,00**



Estrazione della singola chiave senza muovere le altre

224 mm





Inquadra il codice QR  
o vai sul canale YouTube USAG  
per guardare il video dimostrativo



## 280 T/SE7

Cod. U02800903



**7**  
PEZZI

### Serie di 7 chiavi a T con maschio esagonale

- 280 T/2-2,5-3-4-5-6-8 mm
- Per viti con esagono incassato
- Acciaio speciale altamente legato al Silicio Cromo Vanadio
- Esecuzione cromata con estremità brunate per garantire la precisione dimensionale ed il perfetto accompagnamento della vite

~~€ 98,80~~

**€ 69,00**



## 280 TTS/SE6

Cod. U02800760



**6**  
PEZZI

### Serie di 6 chiavi a T maschio esagonali con testa sferica

- 280 TTS/2,5-3-4-5-6-8 mm
- Per viti con esagono incassato
- Acciaio speciale altamente legato al Silicio Cromo Vanadio
- Esecuzione cromata con estremità brunate
- Modello che permette di operare con inclinazioni fino a 30° rispetto all'asse della vite
- Massima accessibilità con la testa sferica

~~€ 86,70~~

**€ 60,50**



## 280 TK/SE6

Cod. U02800020



**6**  
PEZZI

### Serie di 6 chiavi a T maschio esagonale con traversino scorrevole

- 280 TK/2,5-3-4-5-6-8 mm
- Per viti con esagono incassato
- Traversino scorrevole che permette di avere maggiore accessibilità rispetto alla chiave standard
- Fermo di sicurezza che impedisce l'estrazione del traversino
- Acciaio speciale altamente legato al Silicio Cromo Vanadio
- Esecuzione cromata con estremità brunate per il gambo
- Esecuzione interamente brunita per il traversino
- Estremità dimensionate per il perfetto accoppiamento con la vite

~~€ 87,50~~

**€ 58,00**



Punta  
Fosfatata

## 324 SH12

Cod. U03240251



**12**  
PEZZI

Serie di 12 giraviti per viti con intaglio, impronta a croce PHILLIPS® e impronta a croce POZIDRIV® - SUPADRIV®

- 324 D/0,4x2,5x50
- 324/0,5x3x75-0,8x4x100-1x5,5x125-1,2x6,5x150
- 324 N/1x5,5x35
- 324 PH/0x75-1x75-2x100
- 324 NPH/2x35
- 324 PZ/1x75-2x100

~~€ 69,00~~

**€ 45,00**



Punta  
Fosfatata

## 324 SH8

Cod. U03240250



**8**  
PEZZI

Serie di 8 giraviti per viti con intaglio e impronta a croce PHILLIPS®

- 324 D/0,4x2,5x50
- 324/0,5x3x75-0,8x4x100-1x5,5x125-1,2x6,5x150
- 324 PH/0x75-1x75-2x100

~~€ 40,50~~

**€ 26,50**



Punta Fosfatata

**324 LTX/S5**

Cod. U03240067



**8**  
PEZZI

**Serie di 5 giraviti lunghi con impronta TORX®**

- 324 LTX T20x275 - T25x275 - T27x275 - T30x275 - T40x275

~~€ 70,50~~

**€ 49,40**



Punta Fosfatata

**324 STX/S7**

Cod. U03240093



**8**  
PEZZI

**Serie di 7 giraviti con impronta TORX® Tamper Resistant®**

- 324 STX T10x75-T15x75-T20x100-T25x100-T27x100-T30x125-T40x150

~~€ 79,00~~

**€ 55,30**



Punta sabbata

**322 SH10**

Cod. U03220255



**8**  
PEZZI

**Serie di 10 giraviti per viti con intaglio e impronta a croce PHILLIPS®**

- 322 0,4x2x50-0,5x3x75-0,8x4x100-1x5,5x100-1,2x6,5x150
- 322 PH/OX75-1x100-2x125
- 322 PZ 1X100-2X125

~~€ 42,00~~

**€ 29,40**

INTERVENTI DI PRECISIONE

MANUTENZIONE DI PICCOLI  
ELETTRODOMESTICI

APPARECCHIATURE ELETTRONICHE



## 341 SH4TX

Cod. U03410017

4  
PEZZI

### Serie di 4 giraviti di precisione TORX®

- Impugnatura monomateriale ergonomica
- Lame in acciaio con finitura cromata
- Fornito in cassetta di plastica

**NEW**

~~€ 17,10~~

**€ 12,00**

✦ T6-T7-T8-T9

0,2 Kg	L. 135 H. 195 P. 25
--------	---------------------------



## 341 SH6

Cod. U03410018

6  
PEZZI

### Serie di 6 giraviti di precisione per viti con intaglio ed impronta a croce PHILLIPS®

- Impugnatura monomateriale ergonomica
- Lame in acciaio con finitura cromata
- Fornito in cassetta di plastica

**NEW**

~~€ 21,40~~

**€ 15,00**

⊖ 1-1,2-1,5-1,8 mm

⊕ PH00-PH000

0,2 Kg	L. 135 H. 195 P. 25
--------	---------------------------



## 341 SH9

Cod. U03410015

6  
PEZZI

### Giravite di precisione con 8 lame intercambiabili

- Impugnatura monomateriale ergonomica
- Lame in acciaio con finitura cromata
- Fornito in cassetta di plastica

~~€ 15,00~~

**€ 10,50**

+ PH00-PH000

- 1-1,2-1,5-1,8-2-2,5 mm

**NEW**



0,2 Kg



L. 135  
H. 195  
P. 25



## 341 SH17

Cod. U03410016

6  
PEZZI

### Giravite di precisione con 16 lame intercambiabili

- Impugnatura monomateriale ergonomica
- Lame in acciaio con finitura cromata
- Fornito in cassetta di plastica

~~€ 27,10~~

**€ 19,00**

- 1-1,2-1,5-1,8-2-2,5 mm

○ 0,9-1,3-1,5-2 mm

+ PH00-PH000

⊛ T5-T6-T7-T8

**NEW**



0,2 Kg



L. 135  
H. 195  
P. 25



## 341 SH33

Cod. U03410019

6  
PEZZI

### Giravite di precisione portainseriti con 32 inserti

- Impugnatura monomateriale ergonomica
- Fornito in cassetta di plastica

~~€ 32,90~~

**€ 23,00**

- 1-1,2-1,5-1,8-2-2,5-3 mm

⊛ PZ0-PZ1

+ PH0-PH00-PH000

○ 0,9-1,3-1,5-2-2,5-3-4 mm

⊛ T5-T6-T7-T8-T9

⊛ PT2-PT3-PT4

⊛ TT10-TT15-TT20

⊛ PT0-PT1

**NEW**



0,2 Kg



L. 135  
H. 195  
P. 25

## Just USAG



**Kg** 0,3 Kg    **mm** L. 138  
H. 30  
P. 98



**Kg** 0,3 Kg    **mm** L. 138  
H. 30  
P. 98



**Kg** 0,9 Kg    **mm** L. 215  
H. 45  
P. 150



Inquadra il codice QR  
o vai sul canale YouTube USAG  
per guardare il video dimostrativo

**692 J32**  
Cod. U06920042



1/4

**32**  
PEZZI

**Assortimento di inserti con cricchetto**

~~€ 44,90~~    **€ 30,50**

DESCRIZIONE	MISURA		PZ.
Inserti ad intaglio	4-5,5-6,5-8	⊖	4
Inserti a croce Phillips®	PH 1-2-3	⊕	3
Inserti a croce Pozidriv®	PZ 1-2-3	⊕	3
Inserti esagono maschio	3-4-5-6	⊙	4
Inserti TORX®	T8-10-15-20-20-25-25-30-40	⊗	9
Inserti TORX® Tamper Resistant	TX 10-15-20-25-27-30-40	⊗	7
Portainseri magnetico			1
Cricchetto			1

**692 J49**  
Cod. U06920041



1/4

**48**  
PEZZI

**Assortimento di inserti**

~~€ 34,70~~    **€ 25,50**

DESCRIZIONE	MISURA		PZ.
Inserti ad intaglio	4-4,5-5,5-6,5-6,5-8 6	⊖	6
Inserti a croce Phillips®	PH 1-1-2-2-2-3 6	⊕	6
Inserti a croce Pozidriv®	PZ 1-1-2-2-2-3-3 7	⊕	7
Inserti esagono maschio	2-3-3-4-4-5-5-6-6 9	⊙	9
Inserti TORX®	STX 10-15-15-20-20-25-25-30-30-40	⊗	10
Inserti TORX® Tamper Resistant	T 10-10-15-15-20-20-25-25-30-30	⊗	10
Portainseri magnetico			1

**692 J100**  
Cod. U06920043



1/4

**100**  
PEZZI

**Assortimento di inserti con impronte speciali**

~~€ 53,50~~    **€ 39,50**

DESCRIZIONE	MISURA		PZ.
Inserti a intaglio	3-4-4,5-5-5,5-6-6,5-7-8	⊖	9
Inserti a croce	PH 00-0-1-1-2-2-3-4 - PZ 1-2-2-3-4	⊕ ⊕	13
Inserti esagono maschio	1,5-2-2,5-3-4-5-5,5-6-7-8 mm 1/16-5/64-3/32-7/64-1/8-9/64-5/32-3/16-7/32-1/4"	⊙	20
Inserti TORX®	T 8-9-10-15-20-25-27-30-40-45	⊗	10
Inserti TORX® Tamper Resistant	STX 8-10-15-20-25-27-30-40-45	⊗	9
Inserti Tri-Wing	1-2-3-4	⊕	4
Inserti Spanner	4-6-8-10-12	⊕	5
Inserti Torq-set	6-8-10	⊕	3
Inserti quadrati	0-1-2-2-3	⊖	5
Inserti Clutch	1/8-5/32-3/16-1/4-5/16	⊖	5
Inserti XZN	M5-M6-M8	⊗	3
Inserti esagono maschio con foro	2-2,5-3-4-5-6 mm - 5/64-3/32-7/64-1/8-9/64-5/32"	⊙	12
Portainseri magnetici	1/4x60mm		2



**NEW**

**664 B/S7**  
Cod. U06640015

1/4

**7**  
PEZZI

**Assortimento di inserti a bussola**

• Fornito in cassetta di plastica

~~€ 30,00~~

**€ 21,00**

**Kg** 0,3 Kg    L. 138  
H. 30  
P. 98



**5,5-6-7-8-10-12-13 mm**



**NEW**

**664 S25**  
Cod. U06640111

1/4

**25**  
PEZZI

**Assortimento di inserti per avvitatura**

• Fornito in cassetta di plastica

~~€ 56,00~~

**€ 39,00**

DESCRIZIONE/DESCRIPTION	MISURA/SIZE		PCS
Inserti lunghi ad intaglio	3-4-5-6	⊖	4
Inserti lunghi a croce PH	1-2(x2)-3(x2)	⊕	5
Inserti lunghi a croce PZ	1-2(x2)-3(x2)	⊕	5
Inserti lunghi TORX®	T15-T20-T25-T30-T40	⊗	5
Inserti lunghi esagonali	2-3-4-5-5,5	⊙	5
Portainseri magnetico			1

**Kg** 0,8 Kg    L. 215  
H. 45  
P. 150

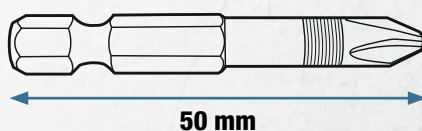

Riconoscimento dell'inserto  
con codice colore per una  
scelta rapida



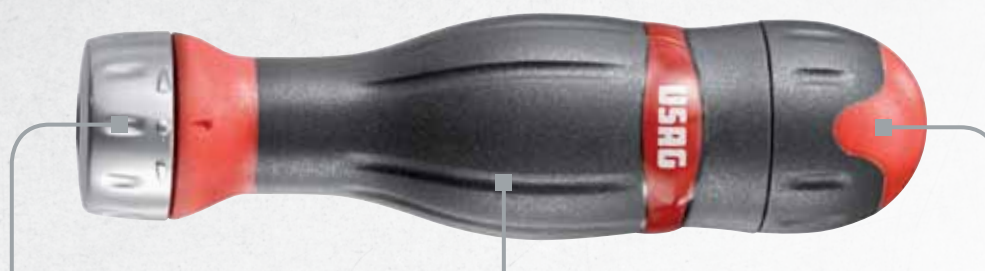

**1** GIRAVITE Con cricchetto reversibile



**2** GIRAVITE con impugnatura a T



**3** GIRAVITE CORTO porta inserti

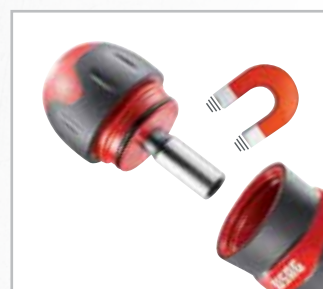

**333 K/S8**  
Cod. U03330042



**8**  
PEZZI

**Assortimento COMBIDRIVE con inserti**  
• Fornito con una selezione di 6 inserti da 1/4"

~~€ 48,44~~

**€ 33,50**

DESCRIZIONE	ARTICOLO/MISURA	PZ
Impugnatura Combidrive	333 K	1
Lama portainseri magnetica	333 1/4 MG	1
Inserti ad intaglio	660/0,6x4,5-1x5,5	2
Inserti a croce PH	660 PH 1-2	2
Inserti esagonali	660 E 3-4	2



Fornito senza inserti USAG 660

**333 K/B10**  
Cod. U03330043



**10**  
PEZZI

**Assortimento COMBIDRIVE in astuccio di nylon**

- Fornito con una selezione di lame
- Include un astuccio da cintura in nylon

~~€ 104,52~~

**€ 70,00**

DESCRIZIONE	ARTICOLO/MISURA	PZ
Impugnatura Combidrive	333 K	1
Lame reversibili ad intaglio	333 I 0,6x3,5/0,8x4-X5,5/1,2X6,5	2
Lame reversibili a croce PH	333 PH 0-1/2-3	2
Lame reversibili Torx T.R.	333 STX/ T7-T8/T9-T10/T15-T20/ T25-T27/T30-T40	5





**ATTENZIONE**  
Rispettare le corrette coppie  
di serraggio evita qualunque  
tipo di danneggiamento  
dell'inserto o della vite



## KIT UNIVERSALE



**NEW**

**824 SK23**

Cod. U08240007

**23**  
PEZZI

**Kit universale per sostituzione inserti da taglio**

- Permette di sostituire gli inserti da taglio utilizzati sugli utensili rotanti delle frese

€ 399,00

**€ 279,00**

DESCRIZIONE	MISURA	PZ.
Giravite dinamometrico	0,5÷2,5 Nm	1
Giravite dinamometrico	1,4÷10 Nm	1
Inserti esagono maschio	2-3-4-5	4
Inserti TORX®	TX 6-7-8-9-10-15-20-25	8
Inserti TORX PLUS®	IP 6-7-8-9-10-15-20-25	8
Portainseriti magnetico		1

## KIT BASE PER VITI GRANDI



**NEW**



## KIT BASE PER VITI PICCOLE



**NEW**



**824 SK11**

Cod. U08240009

**11**  
PEZZI

**Kit base per sostituzione inserti da taglio**

- Permette di sostituire gli inserti da taglio che utilizzano viti TORX®, TORX PLUS® da 15 a 25 e esagonali da 3, 4, 5 mm

€ 213,00

**€ 149,00**

DESCRIZIONE	MISURA	PZ.
Giravite dinamometrico	1,4÷10 Nm	1
Inserti esagono maschio	3-4-5	3
Inserti TORX®	TX 15-20-25	3
Inserti TORX PLUS®	IP 15-20-25	3
Portainseriti magnetico		1

**824 SK13**

Cod. U08240008

**13**  
PEZZI

**Kit base per sostituzione inserti da taglio**

- Permette di sostituire gli inserti da taglio che utilizzano viti TORX®, TORX PLUS® da 6 a 10 e esagonali da 2 mm

€ 213,00

**€ 149,00**

DESCRIZIONE	MISURA	PZ.
Giravite dinamometrico	1,4÷10 Nm	1
Inserti esagono maschio	3-4-5	3
Inserti TORX®	TX 15-20-25	3
Inserti TORX PLUS®	IP 15-20-25	3
Portainseriti magnetico		1

## SERRAGGI DESTROSI

**NEW**



ISO 6789

**810 N**

Precisione  
**±4%**

**Chiave dinamometrica con cricchetto reversibile**

- Modello a coppia regolabile per serraggi destrorsi
- Riarmo automatico al rilascio dopo il disinnesto
- Fornita con certificato di collaudo

ARTICOLO	CODICE	CAPACITÀ	☑	L (MM)	RISOL.
810 N 5	U08104000	1 ÷ 5	1/4"	197	0,05
810 N 25	U08104001	5 ÷ 25	1/4"	290	0,05
810 N 50	U08104002	10 ÷ 50	3/8"	350	0,25
810 N 100	U08104003	20 ÷ 100	1/2"	410	0,25
810 N 200	U08104005	40 ÷ 200	1/2"	475	0,5
810 N 340	U08104006	68 ÷ 340	1/2"	630	1

€ 185,00 **€ 120,00**

€ 191,00 **€ 120,00**

€ 191,00 **€ 120,00**

€ 191,00 **€ 120,00**

€ 193,00 **€ 120,00**

€ 221,00 **€ 140,00**

## SERRAGGI DESTROSI E SINISTRORSI

**NEW**



ISO 6789

**811 NE**

Precisione  
**±4%**

**Chiave dinamometrica**

- Modello a coppia regolabile da utilizzare in abbinamento agli inserti della serie 811
- Serraggi destrorsi e sinistrorsi con rotazione degli inserti di 180°
- Riarmo automatico al rilascio dopo il disinnesto
- Fornita con certificato di collaudo

ARTICOLO	CODICE	CAPACITÀ	☑	RISOL.	ATTACCO	L (MM)
811 NE 5	U08114009	1 ÷ 5	1/4"	0,05	9x12 mm	185
811 NE 25	U08114010	5 ÷ 25	1/4"	0,05	9x12 mm	300
811 NE 50	U08114011	10 ÷ 50	3/8"	0,25	9x12 mm	370
811 NE 100	U08114012	20 ÷ 100	3/8"	0,25	9x12 mm	430
811 NE 100	U08114013	21 ÷ 100	1/2"	0,25	9x12 mm	430
811 NE 200	U08114014	40 ÷ 200	1/2"	0,5	14x18 mm	510
811 NE 340	U08114015	68 ÷ 340	1/2"	1	14x18 mm	665

€ 220,00 **€ 140,00**

€ 227,00 **€ 140,00**

€ 230,50 **€ 145,00**

€ 231,50 **€ 145,00**

€ 234,00 **€ 145,00**

€ 248,50 **€ 150,00**

€ 264,50 **€ 165,00**



Inquadra il codice QR  
o vai sul canale YouTube USAG  
per guardare il video dimostrativo

## NUOVA CHIAVE PER SERRAGGI DESTRORSI UTILIZZABILE DIRITTA O INCLINATA A $\pm 20^\circ$



**TESTA SNODATA**  
inclinabile a  $\pm 20^\circ$

**IMPOSTAZIONE  
DELLA COPPIA**  
rapida e precisa



**IDEALE PER SERRAGGI IN PUNTI CON SCARSA ACCESSIBILITÀ**



**ISO 6789**

**810 F**

Precisione  
 **$\pm 4\%$**

**Chiave dinamometrica con cricchetto reversibile a testa snodata**

- Testa snodata per agevolare l'utilizzo in spazi ridotti o profondi
- Angolo di inclinazione fino a  $20^\circ$
- Scala di lettura in Nm
- Modello a coppia regolabile per serraggi destrorsi
- Riarmo automatico al rilascio dopo il disinnesto
- Fornita con certificato di collaudo



**IMPORTANTE**

Quando la chiave è utilizzata inclinata a  $\pm 20^\circ$  la coppia di serraggio deve essere impostata con un incremento del +5%.

Esempio:

Coppia necessaria 90 Nm  
= Coppia per uso inclinato 94,5 Nm

ARTICOLO	CODICE	CAPACITÀ	☑	L (MM)	RISOL.
810 F 100	U08104013	20 ÷ 100	1/2"	447	0,25
810 F 200	U08104015	40 ÷ 200	1/2"	500	0,5

~~€ 199,00~~ **€ 129,00**

~~€ 199,00~~ **€ 129,00**

## NUOVA GAMMA PINZE REGOLABILI 178 N

**GANASCE MULTIPRESA**  
con durezza 49 HRC.



**PERNO DI FISSAGGIO BREVETTATO**

**IMPUGNATURE ERGONOMICHE**  
rivestite in PVC.

**178 N 250**  
Max 44 mm

**178 N 180**  
Max 30 mm

**CORPO FORGIATO**

**CREMAGLIERA A 8 POSIZIONI**

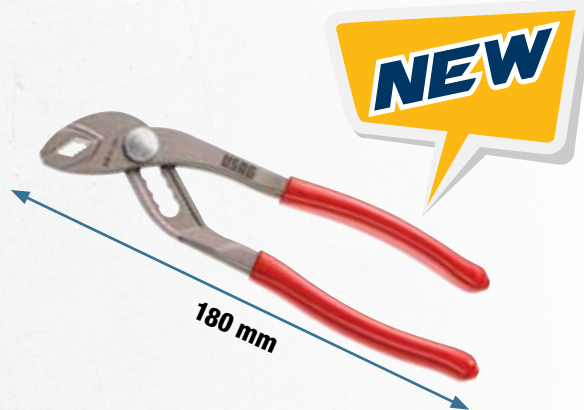
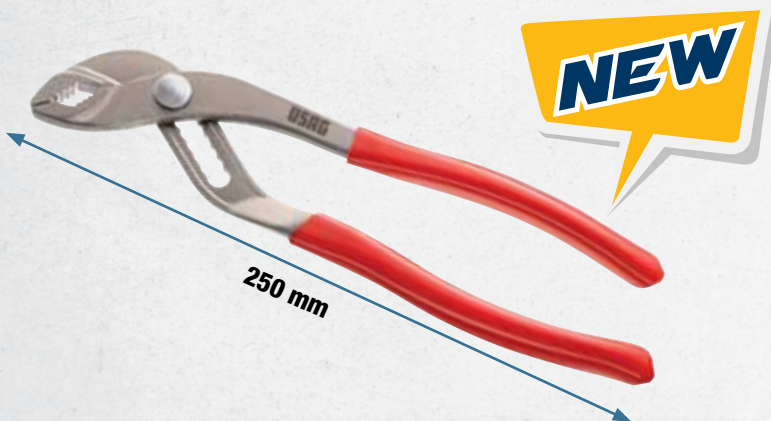

**178 N 250**  
Cod. U01780012

**Pinza regolabile a cerniera sovrapposta**

**178 N 180**  
Cod. U01780011

**Pinza regolabile a cerniera sovrapposta**

~~€ 22,00~~

**€ 14,00**

~~€ 17,00~~

**€ 12,00**



**SISTEMA DI APERTURA  
INNOVATIVO BREVETTATO**

### 135 A

Cod. U01350505

MAX Ø  
80  
mm

**Pinza regolabile autobloccante a cremagliera con ganasce corte**

- Ganasce forgiate
- Dentatura studiata per una presa perfetta anche su tondo
- Sistema di apertura brevettato ed integrato nei manici
- Rullino di regolazione della presa integrato sul manico superiore
- Cremagliera a 5 posizioni

~~€ 57,50~~

**€ 40,50**



### 135 B

Cod. U01350510

MAX Ø  
110  
mm

**Pinza regolabile autobloccante a cremagliera con ganasce lunghe**

- Ganasce forgiate
- Dentatura studiata per una presa perfetta anche su tondo
- Sistema di apertura brevettato ed integrato nei manici
- Rullino di regolazione della presa integrato sul manico superiore
- Cremagliera a 5 posizioni

~~€ 62,50~~

**€ 43,50**



### 150 A/S2

Cod. U01500100

2  
PEZZI

**Assortimento con pinza universale e pinza regolabile a cerniera chiusa**

- Pinza universale 150 A 180
- Pinza regolabile a cerniera chiusa 180 C 250

~~€ 53,80~~

**€ 37,70**



### 150 A/S3

Cod. U01509003P

3  
PEZZI

**Assortimento con pinza universale, pinza a becchi lunghi e tronchese**

- Pinza universale 150 A 180
- Pinza a becchi lunghi 133 A 160
- Tronchese taglio diagonale 188 A 160

~~€ 78,10~~

**€ 54,70**





L'inclinazione a 120° del becco garantisce la massima visibilità

## 115 CP Cod. U01150024



### Pinza piegata a becchi semitondi lunghissimi

- Corpo piegato rispetto all'asse dell'impugnatura per una presa frontale più comoda.
- Maggiore visibilità sul punto in cui si interviene.
- Superficie di presa zigrinata: lunghezza 32 mm.
- Ganasce sagomate anche per la presa sul tondo.
- Tagliente per filo duro integrato.
- Cerniera chiusa con molla di richiamo interna.
- Impugnature ergonomiche rivestite in materiale antiscivolo.

~~€ 31,50~~

**€ 23,00**

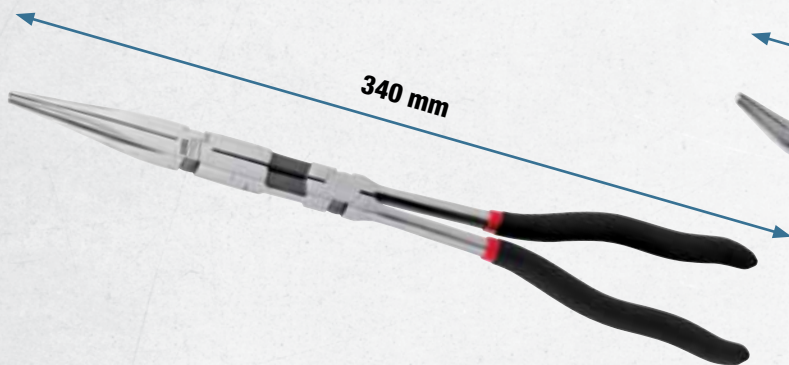

340 mm

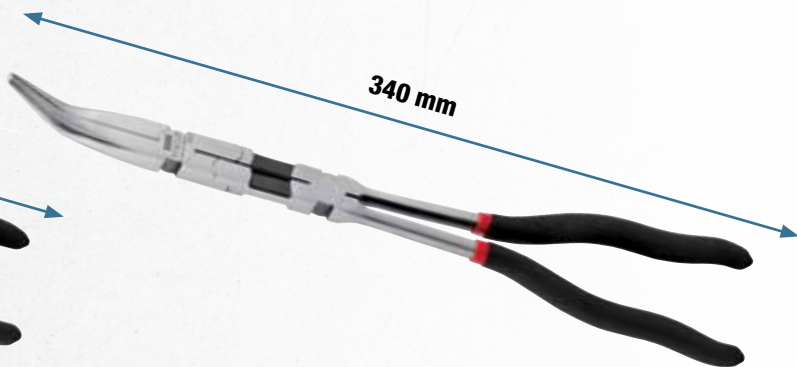

340 mm

## 115 CL Cod. U01150020



### Pinza doppio snodo a becchi mezzotondi dritti

~~€ 33,00~~

**€ 24,10**

## 115 CLP Cod. U01150021



### Pinza doppio snodo a becchi mezzotondi piegati a 45°

~~€ 33,00~~

**€ 24,10**



## 127 N/SE4 Cod. U01279000P

**4  
PEZZI**

### Serie 4 pinze per anelli elastici

- Pinze per anelli elastici interni **127 N 19÷60-127 PN 19÷60**
- Pinze per anelli elastici esterni **128 N 19÷60-128 PN 19÷60**

~~€ 85,40~~

**€ 59,50**



## 085 N/S2

Cod. U00859000P



**2**  
PEZZI

### Assortimento con pinza universale e tronchese diagonale

- Pinza universale 085 N 180
- Tronchese taglio diagonale 087 N 160

~~€ 70,00~~ **€ 49,00**



## 092 SH5

Cod. U00920100



**5**  
PEZZI

### Serie di 5 giraviti per viti con intaglio e per viti con impronta a croce PHILLIPS®

- 092/0,5x3x75-0,8x4x100-1x5,5x125
- 092 PH/1x100-2x125

~~€ 38,30~~ **€ 28,70**



## 092 D/SH5

Cod. U00920119



**5**  
PEZZI

### Serie di 5 giraviti SLIM per viti con intaglio e per viti con impronta a croce PHILLIPS®

- 092 D/0,6x3,5x100-0,6x4x100-1x5,5x125
- 092 DPH/1x100-2x125

~~€ 45,90~~ **€ 34,00**



## 092 DPHB/SE2

Cod. U00920122



**5**  
PEZZI

### Serie di 2 giraviti SLIM per viti con impronta combinata intaglio / PHILLIPS®

- 092 DPHB/1x100-2x125

~~€ 19,60~~ **€ 14,50**



**NEW**



Ø 4,5÷40 mm

**162**

Cod. U01620001

### Sguainacavi regolabile

- Utensile sguainacavi professionale per cavi di potenza, cavi elettrici, cavi di comando multiconduttore, cavi in fibra ottica e cavi multipolari di rame
- Doppia staffa per il posizionamento del cavo: maggiore capacità
- Permette spellature circolari, longitudinali ed a spirale

~~€ 60,00~~

**€ 42,00**



**NEW**

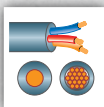

0,02÷10 mm<sup>2</sup>

**146 A**

Cod. U01460003

### Pinza spellafili automatica diritta

- Funzioni di taglio e spellatura dei fili elettrici
- Capacità 0,02-10 mm<sup>2</sup>/AWG 34-80
- Ganasce intercambiabili senza uso di utensili
- Tagliafilì integrato nel corpo dell'utensile

~~€ 86,00~~

**€ 59,00**



**NEW**

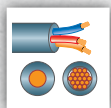

0,02÷10 mm<sup>2</sup>

**146 B**

Cod. U01460004

### Pinza spellafili automatica piegata a 90°

- Funzioni di taglio e spellatura dei fili elettrici
- Capacità 0,02-10 mm<sup>2</sup>/AWG 34-80
- Ganasce intercambiabili senza uso di utensili
- Tagliafilì integrato nel corpo dell'utensile

~~€ 99,00~~

**€ 69,00**

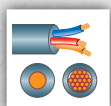

4÷16 mm<sup>2</sup>



**NEW**

**146 R**

Cod. U01460004Q

### Ricambio ganasce

- Compatibile con i modelli 146 A e 146 B

~~€ 40,00~~

**€ 28,00**





**0,14÷10 mm<sup>2</sup>**  
AWG 26-8

**NEW**



NON ISOLATO

ISOLATO

**753 KA**

Cod. U07530004

**Crimpatrice autoregolante per puntalini a sezione quadra**

- Per puntalini isolati e non isolati
- Capacità 0,14-10 mm<sup>2</sup>/AWG 26-8
- Sistema di ripresa per operazioni multiple consecutive
- Permette di crimpare applicando poca forza sulle impugnature

~~€ 200,00~~ **€ 139,00**



**NEW**

**INCLUSI**



**0,1÷6 mm<sup>2</sup>**  
AWG 26-10

**0,5÷2,5 mm<sup>2</sup>**  
AWG 22-14

**754 A**

Cod. U07540002

**Crimpatrice a matrici intercambiabili**

- Matrici facilmente sostituibili
- Impugnatura ad angolo retto per maggiore visibilità durante l'utilizzo
- Leve maggiorate per uno sforzo ridotto, e per una presa a una o due mani
- Fornita con 2 matrici:
  - per capicorda pre-isolati, 0,1-6 mm<sup>2</sup>/AWG 26-10 (verde, giallo)
  - per capicorda pre-isolati, 0,5-2,5 mm<sup>2</sup>/AWG 22-14 (blu, rosso)

~~€ 195,00~~ **€ 137,00**

## MATRICI OPZIONALI (acquistabili separatamente)

**NEW**



**0,25÷10 mm<sup>2</sup>**  
AWG 24-8

**754 MC**

Cod. U07540004Q

**Matrice**

~~€ 58,00~~ **€ 40,50**

**NEW**



**0,5÷6 mm<sup>2</sup>**  
AWG 22-10

**754 MD**

Cod. U07540005Q

**Matrice**

~~€ 80,00~~ **€ 56,00**

## NUOVA GAMMA SALDATORI A STILO

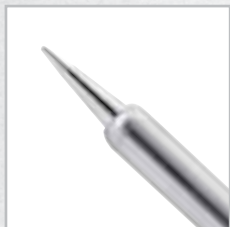

**NEW**



2011/65/UE  
2012/19/EC

### 061 W

#### Saldatori a stilo elettronici

- Saldatori professionali per stagno
- Ideali per diversi tipi di applicazioni in campo elettrotecnico
- Punta in acciaio ad alta durata
- Corpo in materiale plastico resistente ad olii ed idrocarburi
- Alimentazione 230V
- Forniti con supporto da banco

CODICE	POTENZA W	TEMPERATURA MAX	PESO Gr
U00610022	15	396 °C	30
U00610023	20	495 °C	30
U00610024	25	495 °C	30

~~€ 50,00~~ **€ 35,00**

~~€ 50,00~~ **€ 35,00**

~~€ 50,00~~ **€ 35,00**



**NEW**



2011/65/UE  
2012/19/EC

### 063 W

Cod. U00630002

**15÷25**  
WATT

**MAX**  
495°C

#### Saldatore a stilo elettronico a doppia potenza

- Saldatore professionale per stagno
- Commutatore di potenza a pulsante
- Ideale per diversi tipi di applicazioni in campo elettrotecnico
- Punta in acciaio ad alta durata
- Corpo in materiale plastico resistente ad olii ed idrocarburi
- Alimentazione 230V
- Fornito con supporto da banco

~~€ 55,00~~

**€ 38,50**



## 207 C

Cod. U02070004

### Forbice per elettricisti

- Modello con lama microdentata antiscivolo
- Impugnature ergonomiche grandi bimalteriali
- Ganasce stringitubo per tubo corrugato
- Corpo in acciaio Inox con rivestimento al Titanio

~~€ 13,10~~

**€ 9,80**



## 367 SE6

Cod. U03670081

**6**  
PEZZI

### Serie di 6 cacciaspine

- 367/2x110-3x130-4x145-5x165-6x180-8x200 mm

~~€ 46,50~~

**€ 32,60**

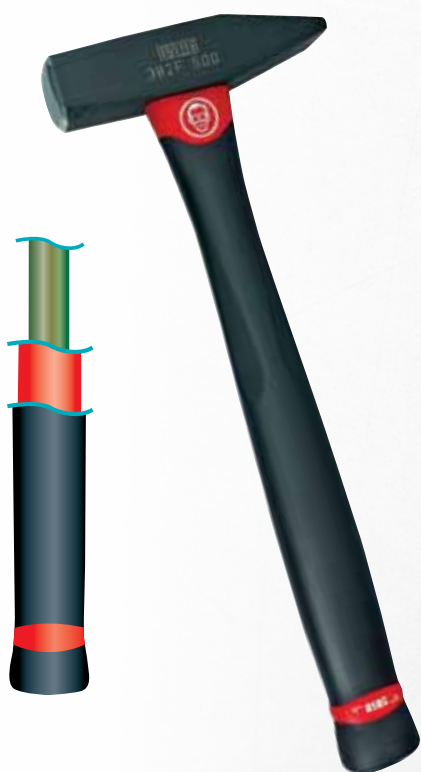

## 382 F

### Martelli per meccanici manico in graphite

- Modello tedesco a testa quadra piana e penna simmetrica
- Manico in graphite

CODICE	PESO (GR)	LUNGHEZZA (MM)
U03820102	200	285
U03820103	300	300
U03820105	500	310
U03820107	800	350
U03820108	1000	355

~~€ 15,90~~

**€ 11,60**

~~€ 17,00~~

**€ 12,40**

~~€ 19,30~~

**€ 14,10**

~~€ 23,80~~

**€ 17,40**

~~€ 25,80~~

**€ 18,80**

## TAGLIATUBI LEGGERI



RAME



### 314 A

Cod. U03140010

Ø  
3-16  
mm

Ø  
1/8-5/8  
"

#### Tagliatubi per tubi in rame e lega leggera

- Modello compatto a limitato raggio di rotazione per operare in spazi ristretti.
- Rulli di scorrimento scanalati per il taglio di tubi bordati.
- Spessore massimo: 2 mm.
- Corpo in lega leggera.
- Esecuzione verniciata.

€ 24,60

€ 17,20

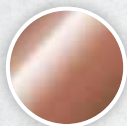

RAME



### 314 B

Cod. U03140031

Ø  
3-35  
mm

Ø  
1/8-1 3/8  
"

#### Tagliatubi per tubi in rame e lega leggera

- Modello compatto a limitato raggio di rotazione per operare in spazi ristretti
- Rulli di scorrimento scanalati per il taglio di tubi bordati
- Sostituzione rapida della rotella senza bisogno di utensili
- Pomello ergonomico
- Corpo in lega leggera
- Esecuzione verniciata
- Spessore massimo tubo: 2 mm
- Fornito con 2 rotelle, una montata e una nel pomello

€ 30,00

€ 21,00

Inserto in acciaio filettato per uno scorrimento rapido

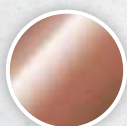

RAME



### 314 C

Cod. U03140032

Ø  
3-30  
mm

Ø  
1/8-1 1/8  
"

#### Tagliatubi per tubi in rame e lega leggera

- Rulli di scorrimento scanalati per il taglio di tubi bordati
- Sostituzione rapida della rotella senza bisogno di utensili
- Pomello ergonomico
- Corpo in lega leggera
- Esecuzione verniciata
- Spessore massimo tubo: 2 mm

€ 30,00

€ 21,00

## TAGLIATUBI DI PRECISIONE



RAME

**314 DA**

Cod. U03140033

Ø  
3-35  
mmØ  
1/8-1 3/8  
"**Tagliatubi per tubi in rame e lega leggera**

- Modello ad avanzamento telescopico e ingombro costante
- 4 rulli di scorrimento scanalati per il taglio di tubi bordati
- Sostituzione rapida della rotella senza bisogno di utensili
- Pomello ergonomico
- Corpo in lega leggera
- Esecuzione verniciata
- Spessore massimo tubo: 2 mm
- Lama svasatubi incorporata
- Fornito con 2 rotelle, una montata e una nel pomello

~~€ 59,00~~**€ 41,00**

INOX

**314 DB**

Cod. U03140034

Ø  
3-35  
mmØ  
1/8-1 3/8  
"**Tagliatubi per tubi in acciaio inox**

- Modello ad avanzamento telescopico e ingombro costante
- 4 rulli di scorrimento in acciaio inox con cuscinetti interni
- Sostituzione rapida della rotella senza bisogno di utensili
- Pomello ergonomico
- Corpo in lega leggera
- Esecuzione verniciata
- Spessore massimo tubo: 2,5 mm
- Lama svasatubi incorporata
- Fornito con 2 rotelle, una montata e una nel pomello

~~€ 75,00~~**€ 52,00**

## TAGLIATUBI CON AVANZAMENTO RAPIDO

Dispositivo di avanzamento e ritorno rapido a cremagliera

Sostituzione rapida della rotella senza bisogno di utensili

4 rulli di scorrimento

Fornito con 2 rotelle: 1 montata e 1 nel pomello

Lama svasatubi incorporata

**NEW**



**NEW**



**RAME**

**314 FA**

Cod. U03140037

Ø  
6-76  
mm

Ø  
1/4-3  
"

**Per tubi in rame e lega leggera**

- Spessore massimo tubo: 2 mm
- Rulli scanalati per il taglio di tubi bordati

~~€ 95,00~~

**€ 66,50**



**NEW**



**INOX**

**314 FB**

Cod. U03140038

Ø  
6-76  
mm

Ø  
1/4-3  
"

**Per tubi in acciaio inox**

- Spessore massimo tubo: 2,5 mm
- Rulli in acciaio inox con cuscinetti interni

~~€ 115,00~~

**€ 80,50**



**NEW**



**PLASTICA**

**314 FC**

Cod. U03140039

Ø  
6-76  
mm

Ø  
1/4-3  
"

**Per tubi in plastica**

- Spessore massimo tubo: 8,6 mm
- Rulli scanalati per il taglio di tubi bordati

~~€ 105,00~~

**€ 73,50**



PLASTICA

**317 C**

Cod. U03170004

Ø  
63  
mmØ  
2,1-2,1/2  
"**Tagliatubi per tubi e profilati in plastica**

- Modello a cremagliera per un'azione di taglio progressiva con il minimo sforzo
- Tagliatubi utilizzato per il taglio rapido di tubi in PVC, PP, PE, PER, ABS, PEHD
- Lama trattata per un taglio a squadra e senza sbavature
- Corpo in lega leggera
- Esecuzione verniciata

~~€ 135,00~~**€ 94,00****NEW**

PLASTICA

**317 K**

Cod. U03170012

Ø  
32  
mmØ  
1.1/4  
"**Tagliatubi per tubi in plastica**

- Per il taglio di tubi in PEX, PEHD, PVC, PER
- Modello a cremagliera per un'azione di taglio progressiva con il minimo sforzo
- Corpo in lega leggera
- Esecuzione verniciata

~~€ 46,30~~**€ 32,50****305 N****Giratubi modello svedese con ganasce a 90° diritte**

- Acciaio al Cromo Vanadio

CODICE	CAPACITÀ (")	CAPACITÀ (MM)	LUNGHEZZA
U03050002	1	65	330
U03050003	1 1/2"	85	420
U03050004	2"	100	540
U03050005	3	150	690

~~€ 32,40~~**€ 22,70**~~€ 43,20~~**€ 30,20**~~€ 66,50~~**€ 46,60**~~€ 99,00~~**€ 69,30**



## 454 SE3

Cod. U04549002P

**3**  
PEZZI

**Serie di 3 estrattori a due bracci per esterni**  
• 454/0-1-2

~~€ 226,00~~ **€ 158,00**



**COMPRESSE  
NEL PREZZO**

## 451 N/S4

Cod. U04510100

**3**  
PEZZI

**Estrattore a tre bracci per esterni**

- Modello a bracci autoserranti
- Capacità: 7÷140 mm
- Potenza: 3 ton
- Spina di sicurezza
- Vite di manovra con esagono da 18 mm
- Possibilità di utilizzo a due bracci
- Viti di manovra M16x2

~~€ 202,00~~ **€ 141,00**

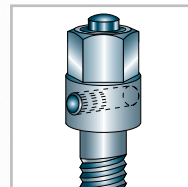

Spina di sicurezza aumenta la sicurezza nell'utilizzo e preserva la qualità dell'attrezzo

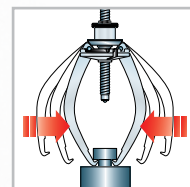

Autoserrante  
Autocentrante



## 458 BK/S11

Cod. U04580311

**11**  
PEZZI

**Serie di 11 estrattori per dadi danneggiati**

- Fornita con guida in lamiera
- Quadro di manovra 3/8 (8-10-11-12-13-14 mm)
- Quadro di manovra 1/2 (15-16-17-18-19 mm)

~~€ 165,00~~ **€ 116,00**

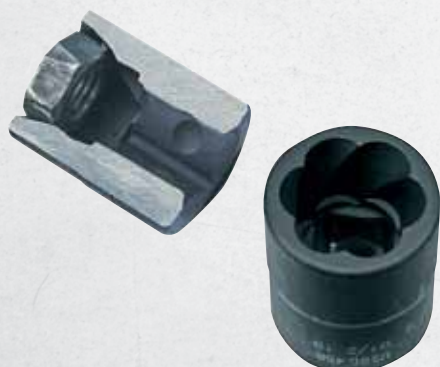

**SOLO PER USO MANUALE.**  
NON UTILIZZARE CON UTENSILI  
PNEUMATICI O ELETTRICI.



CE  
EC CLASS II

**NEW**



**981 A 3**

Cod. U09810036

**Flessometro  
con rivestimento antiurto**

- Larghezza nastro 19 mm

**3  
METRI**

€ 8,71

**€ 6,10**



**981 A 5**

Cod. U09810037

**Flessometro  
con rivestimento antiurto**

- Larghezza nastro 28 mm

**5  
METRI**

€ 14,80

**€ 10,40**



**981 A 8**

Cod. U09810038

**Flessometro  
con rivestimento antiurto**

- Larghezza nastro 28 mm

**8  
METRI**

€ 17,40

**€ 12,20**



Nastro in acciaio  
rivestito in nylon  
resistente



Rigidità nastro garantita  
fino a 1,7 m (3 m)  
e 2,7 m (5-8 m)

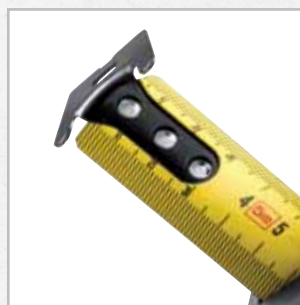

Gancio fissato  
con triplo rivetto



Clip in acciaio Inox



**889 SL**  
Cod. U08890013

POWER  
SMD  
LED

MAX  
**240**  
LUMEN

**Lampada di ispezione a LED  
Extra sottile**

~~€ 141,00~~

**€ 96,00**

#### CARATTERISTICHE TECNICHE

Tipo e numero LED	10 Power LED SMD
Luminosità (modalità normale)	120 Lumen / 175 Lux
Luminosità (modalità boost)	240 Lumen / 350 Lux
Tipo batteria	Li-ION 3.7 V 2400 mAh
Autonomia (modalità normale)	8 ore
Autonomia (modalità boost)	4 ore
Tempo di ricarica	3 ore
Temperatura di utilizzo	-10°C ÷ +50°C



**DOPPIA LUMINOSITÀ**  
Funzione normale o Boost

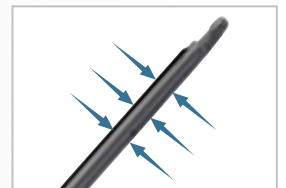

**EXTRA SOTTILE**  
Solo 11 mm



**RESISTENTE**  
Non si rompe sotto  
il peso di un'auto



**889 RB**  
Cod. U08890032

STRIP  
LED

MAX  
**110**  
LUMEN

**Lampada di ispezione a LED**

~~€ 91,50~~

**€ 64,00**

#### CARATTERISTICHE TECNICHE

Tipo e numero LED (funzione lampada)	1 strip LED
Tipo e numero LED (funzione torcia)	5 LED SMD
Luminosità (funzione lampada)	110 Lumen / 270 Lux
Luminosità (funzione torcia)	12 Lumen / 58 Lux
Tipo batteria	Li-ION 3.7 V 2300 mAh
Autonomia (funzione lampada)	4,5 ore
Autonomia (funzione torcia)	20 ore
Tempo di ricarica	4/5 ore
Categoria protezione	IP 20
Temperatura di utilizzo	-20° ÷ +40°C



**TORCIA**

**12** **20**  
LUMEN ORE



**LAMPADA**

**110** **4,5**  
LUMEN ORE



**889 LT**  
Cod. U08890014

POWER  
LED  
SMD

MAX  
**45**  
LUMEN

**Lampada frontale a LED**

~~€ 53,00~~

**€ 37,00**

**CARATTERISTICHE TECNICHE**

Tipo e numero LED	1 Power LED SMD
Tipo batteria	3 x AAA (fornite)
Temperatura di utilizzo	-20°C ÷ +70°C

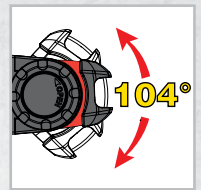

Orientabile  
fino a 104°



Bordo  
paraurti



**MODALITÀ I**



**550**  
LUMEN

**4**  
ORE

**MODALITÀ II**



**1150**  
LUMEN

**2,5**  
ORE

**889 RC**  
Cod. U08890033

POWER  
LED  
SMD

MAX  
**1150**  
LUMEN

**Lampada LED sotto cofano ricaricabile**

~~€ 202,00~~

**€ 137,00**

**CARATTERISTICHE TECNICHE**

Tipo e numero LED	28 Power LED SMD
Luminosità (Mod. I)	550 Lumen / 240 Lux
Luminosità (Mod. II)	1150 Lumen / 440 Lux
Tipo batteria	Li-ION 7.4 V 4000 mAh
Tempo di ricarica	3/4 ore

**CARATTERISTICHE TECNICHE**

Autonomia (Mod.I)	4 ore
Autonomia (Mod.II)	2,5 ore
Categoria protezione	IP 20
Temperatura di utilizzo	-20° ÷ +40°C
Estensione (min-max)	1140 ÷ 1900 mm

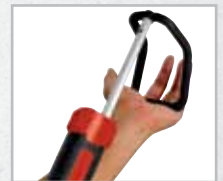

**COB LED  
15W**

**360°**

**889 RT**  
Cod. U08890038

MAX  
**1200**  
LUMEN

**Lampada LED da terra ricaricabile**

~~€ 222,00~~

**€ 150,00**



**DOPIA LUMINOSITÀ**  
Funzione normale o Boost

**CARATTERISTICHE TECNICHE**

Tipo e numero LED	1 COB LED 15 W
Luminosità (modalità normale)	650 Lumen / 350 Lux
Luminosità (modalità boost)	1200 Lumen / 600 Lux
Tipo batteria	Li-ION 11,1 V 4000 mAh
Autonomia (modalità normale)	7 ore
Autonomia (modalità boost)	4 ore
Tempo di ricarica	3/4 ore
Categoria di protezione	IP 65



**IP 65**

**UTILIZZABILE  
ALL'ESTERNO**

**RICARICABILE**

## AVVITATORE AD IMPULSI EXTRA COMPATTO



QUADRO DA 1/2"

**NEW**

SELETORE  
VELOCITÀ

IMPUGNATURA  
BIMATERIALE



**942 PC3 1/2**

Cod. U09420012

  
Kg 1,3

MAX  
**861**  
Nm

### Avvitatore ad impulsi - extra compatto

- Struttura extra compatta: 11 cm di lunghezza
- Modello reversibile con sistema di percussione JUMBO
- Motore monoblocco
- Scarico dell'aria convogliato nell'impugnatura
- 3 livelli di potenza impostabili per il serraggio, coppia sempre al massimo in svitatura
- Corpo ed impugnatura in materiale antiscivolo
- Paracolpi laterali a protezione del carter motore
- Peso bilanciato per il massimo comfort anche per uso prolungato

#### CARATTERISTICHE TECNICHE

Capacità	M16
Coppia massima	861 Nm
Coppia di lavoro	150-220 Nm
Impulsi al minuto	1650
Velocità	10000 rpm
Consumo medio aria	127 l/min
Attacco filettato	1/4"
Diametro interno minimo tubo aria	10 mm
Pressione esercizio	6,2 bar
Livello sonoro (vuoto/lavoro)	91,1/108,1 dB
Livello vibrazione	9,57 m/s <sup>2</sup>

~~€ 208,00~~

**€ 146,00**



## 942 PC1 1/2"

Cod. U09420002

Kg 2,1

**MAX**  
1700  
Nm

### Avvitatore in titanio

- Coppia di lavoro: 200÷450 Nm
- Modello reversibile con meccanismo a doppio martello
- Motore monoblocco
- 3 livelli di potenza impostabili per il serraggio, coppia sempre al massimo in svitatura
- Corpo in resina ad alta resistenza con carter anteriore in titanio
- Impugnatura bimateriale soft-touch
- Paracolpi laterali in gomma
- Peso bilanciato per il massimo comfort anche per uso prolungato

~~€ 411,00~~

**€ 288,00**

CARATTERISTICHE TECNICHE		CARATTERISTICHE TECNICHE	
Capacità	M20	Attacco filettato	1/4"
Coppia massima	1700 Nm	Diametro interno minimo tubo aria	10 mm
Coppia di lavoro	70÷750 Nm	Pressione di esercizio	6,2 bar
Velocità libera	8000 giri/min	Livello sonoro a vuoto/a lavoro	97,6 dB(A)/108,6 dB(A)
Consumo medio aria	141,68 l/min	Livello vibrazione	4,91 m/s2



## 928 PC1 1/2"

Cod. U09280060

Kg 2,4

**MAX**  
1080  
Nm

### Avvitatore in composito

- Coppia di lavoro: 100÷400 Nm
- Meccanismo a doppio martello
- Coppia di lavoro regolabile
- Carcassa ultraleggera in materiale composito ad alta resistenza
- Carter anteriore in acciaio

~~€ 302,00~~

**€ 211,00**

CARATTERISTICHE TECNICHE		CARATTERISTICHE TECNICHE	
Capacità	M16	Attacco filettato	1/4"
Coppia massima	1080 Nm	Diametro interno minimo tubo aria	10 mm
Impulsi al minuto	1060	Pressione di esercizio	6,2 bar
Velocità	8000 giri/min	Livello sonoro a vuoto/a lavoro	96 dB(A)/109 dB(A)
Consumo medio aria	143 l/min	Livello vibrazione	1,45 m/s2



## 928 C1 1/2"

Cod. U09280010

Kg 2,6

**MAX**  
1015  
Nm

### Avvitatore in alluminio

- Coppia di lavoro: 150÷380 Nm
- Modello reversibile con meccanismo a doppio martello
- Coppia di lavoro regolabile

~~€ 254,00~~

**€ 178,00**

CARATTERISTICHE TECNICHE		CARATTERISTICHE TECNICHE	
Capacità	M16	Attacco filettato	1/4"
Coppia massima	1015 Nm	Diametro interno minimo tubo aria	10 mm
Impulsi al minuto	950	Pressione di esercizio	6,2 bar
Velocità	8000 giri/min	Livello sonoro a vuoto/a lavoro	93 dB(A)/104 dB(A)
Consumo medio aria	120 l/min	Livello vibrazione	1,3 m/s2



## 928 PD1 3/4"

Cod. U09280065

Kg 3,9

**MAX**  
1950  
Nm

### Avvitatore in composito

- Coppia di lavoro: 200÷750 Nm
- Modello reversibile con meccanismo a doppio martello, scarico dell'aria convogliato attraverso l'impugnatura, coppia di lavoro regolabile
- Carcassa ultraleggera in materiale composito ad alta resistenza e carter anteriore in acciaio

~~€ 904,00~~

**€ 633,00**

#### CARATTERISTICHE TECNICHE

Capacità	M27
Coppia massima	1950 Nm
Impulsi al minuto	850
Velocità	6360 giri/min
Consumo medio aria	125 l/min

#### CARATTERISTICHE TECNICHE

Attacco filettato	3/8"
Diametro interno min. tubo aria	13 mm
Pressione di esercizio	6,2 bar
Livello sonoro a vuoto/a lavoro	99,1 dB(A)/110,1 dB(A)
Livello vibrazione	10,7 m/s <sup>2</sup>



## 928 D1 3/4"

Cod. U09280015

Kg 5,6

**MAX**  
2400  
Nm

### Avvitatore in alluminio

- Coppia di lavoro: 500÷1050 Nm
- Modello reversibile con scarico dell'aria convogliato attraverso l'impugnatura

~~€ 786,00~~

**€ 550,00**

#### CARATTERISTICHE TECNICHE

Capacità	M24
Coppia massima	2400 Nm
Impulsi al minuto	790
Velocità	5500 giri/min
Consumo medio aria	193 l/min

#### CARATTERISTICHE TECNICHE

Attacco filettato	3/8"
Diametro interno min. tubo aria	13 mm
Pressione di esercizio	6,2 bar
Livello sonoro a vuoto/a lavoro	98,4 dB(A)/109,4 dB(A)
Livello vibrazione	1,61 m/s <sup>2</sup>



## 942 PEL2 1"

Cod. U09420007

Kg 9

**MAX**  
3390  
Nm

### Avvitatore reversibile ad impulsi

- Corpo in materiale composito
- Modello reversibile con meccanismo a doppio martello
- Pulsante progressivo
- Scarico dell'aria posto nella parte inferiore del corpo orientato in avanti a 45°
- 2 livelli di potenza in avvitamento
- Impugnatura bimateriale soft-touch
- Dotato di maniglia ausiliaria
- Sistema di trattenimento della bussola sul quadro di manovra

~~€ 1.086,00~~

**€ 760,00**



30.000  
GIRI/MIN

**922 B1**

Cod. U09220001

0,3  
CV

220  
WATT

76  
l/min

Smerigliatrice diritta

~~€ 130,00~~

**€ 91,00**



25.000  
GIRI/MIN

**922 B2**

Cod. U09220002

0,5  
CV

368  
WATT

113  
l/min

Smerigliatrice diritta alta potenza

~~€ 187,00~~

**€ 131,00**



28.000  
GIRI/MIN

**922 BL1**

Cod. U09220003

0,3  
CV

220  
WATT

76  
l/min

Smerigliatrice mandrino lungo

~~€ 167,00~~

**€ 117,00**



23.000  
GIRI/MIN

**922 BP1**

Cod. U09220004

0,3  
CV

220  
WATT

76  
l/min

Smerigliatrice angolare 90°

~~€ 167,00~~

**€ 117,00**



23.000  
GIRI/MIN

**922 BR1**

Cod. U09220005

0,3  
CV

220  
WATT

76  
l/min

Smerigliatrice angolare 120°

~~€ 167,00~~

**€ 117,00**

## NUOVA GAMMA DI TOOL BOX



1,2 Kg		L. 394 H. 162 P. 220
--------	--	----------------------------

2,1 Kg		L. 486 H. 236 P. 266
--------	--	----------------------------

2,8 Kg		L. 595 H. 260 P. 281
--------	--	----------------------------

**641 TA**

Cod. U06410004

**16"**

**Cassetta portautensili (vuota)**

~~€ 18,00~~

**€ 12,60**

**641 TB**

Cod. U06410005

**19"**

**Cassetta portautensili (vuota)**

~~€ 27,00~~

**€ 18,90**

**641 TC**

Cod. U06410006

**24"**

**Cassetta portautensili (vuota)**

~~€ 36,00~~

**€ 25,20**



Sistema di apertura con una sola mano

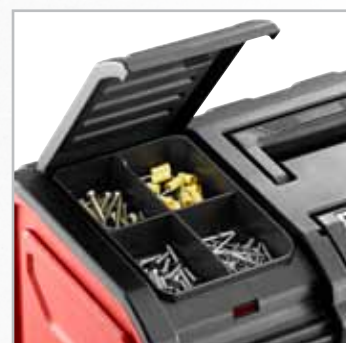

2 scomparti portaminuteria sul coperchio



Possibilità di chiusura con lucchetto (non fornito)



Vassoio interno amovibile





## 532 C

Cod. U05320007

 Kg 16

### Baule portautensili (vuoto)

- Apertura ad arresto a 95°
- Gancio per chiusura a lucchetto
- Struttura in lamiera di acciaio, spessore 1,2 mm

~~€ 132,00~~

**€ 92,00**



## 532 D

Cod. U05320008

 Kg 19

### Baule portautensili (vuoto)

- Apertura ad arresto a 95°
- Gancio per chiusura a lucchetto
- Struttura in lamiera di acciaio, spessore 1,2 mm

~~€ 173,00~~

**€ 121,00**



## 646/5V

Cod. U06460201

**5**  
SCOMPARTI

 Kg 5,9

### Cassetta estensibile (vuota)

- Dimensioni interne:
  - vano 447x207x102 mm
  - scomparti 447x103x52 mm

~~€ 48,90~~

**€ 34,00**



## 646/5LV

Cod. U06460301

**5**  
SCOMPARTI

 Kg 6,6

### Cassetta estensibile LUNGA (vuota)

- Dimensioni interne:
  - vano 537x207x102 mm
  - scomparti 537x103x52 mm

~~€ 55,00~~

**€ 38,50**

Tasche interne  
portautensili



	0,8 Kg		L. 400 H. 290 P. 60
--	--------	--	---------------------------

## 007 PCV

Cod. U00070032



### Borsa porta Notebook (vuota)

- Nylon ad altissima resistenza
- Tre pratiche tasche interne
- Tracolla amovibile per un confort extra nel trasporto
- Due maniglie superiori per una migliore presa
- Cinghia posteriore per fissare la borsa al trolley
- Può contenere Notebook fino a 15,6"
- Dimensioni interne: L370xP50xH280 mm.

~~€ 26,30~~

**€ 19,50**



Tasche interne  
portautensili

## 007 SV

Cod. U00070004



CAPACITA'  
**30L**

### Zaino professionale portautensili (vuoto)

- Nylon ad altissima resistenza
- Cinturino pettorale regolabile
- Cinghie in vita imbottite per distribuire uniformemente il peso
- Base rigida resistente all'acqua
- Vano interno portautensili
- Tasche laterali e frontali
- Portadocumenti interno
- Tasca posteriore interna porta Notebook fino a 15,6"

~~€ 76,50~~

**€ 57,50**

	3,1 Kg		L. 355 H. 225 P. 460
--	--------	--	----------------------------



Tasca posteriore per  
notebook e documenti



Cinturino pettorale  
e cinghie in vita per  
distribuire il peso



	2,5 Kg		L. 420 H. 340 P. 240
--	--------	--	----------------------------

## 007/1V

Cod. U00070001

MAX  
  
11 kg

### Borsa professionale portautensili (vuota)

- Nylon ad altissima resistenza
- Base rigida e resistente all'acqua
- Pratici e comodi vani interni portautensili
- Due tasche frontali portaminuteria
- Pratico maniglione in alluminio con impugnatura rivestita in pelle per una comoda presa
- Ganci interni porta flessometro ed elastici portautensili
- Mantella di chiusura tramite velcro



Tutta l'attrezzatura a portata di mano

~~€ 63,50~~

**€ 47,50**



	160 g		L. 160 H. 265 P. 5
--	-------	--	--------------------------

## 007 MV

Cod. U00070035

4  
TASCHE

### Marsupio portautensili (vuoto)

- Tessuto ad altissima resistenza
- Sistema di fissaggio alla cintura con chiusura in velcro
- 4 tasche portautensili elasticizzate
- Gancio portanastro



Gancio portanastro

~~€ 16,90~~

**€ 12,50**

Può contenere utensili di grandi dimensioni (es. giratubi fino a 2")



	1,5 Kg		L. 540 H. 210 P. 155
--	--------	--	----------------------------

## 007 PMV

Cod. U00070045

MAX  
  
15 kg

CAPACITA'  
12L

### Borsa termoidraulico con rivestimento in PVC (vuota)

- Struttura semi-rigida impermeabile rivestita in PVC
- Base rigida rivettata per aumentare la resistenza al carico
- Tracolla amovibile per un comfort extra nel trasporto
- Due maniglie interne
- Chiusura tramite fibbie a scatto con sgancio rapido



Tasca portadocumenti



Base in PVC impermeabile

~~€ 66,50~~

**€ 49,50**



**NEW**

Kg	5,7 Kg	mm	L. 465
			H. 352
			P. 215

## 001 RH14

Cod. U00010114

**14**  
PEZZI

### Valigia con assortimento per elettrotecnica

- Due pannelli interni amovibili con elastici portautensili
- Vano inferiore con divisori amovibili e regolabili
- Doppia serratura con chiave
- Maniglia ergonomica rivestita in gomma
- 3 cerniere posteriori e doppio braccetto di tenuta coperchio in metallo
- Gusci in polipropilene ad alto spessore montati su un'intelaiatura di alluminio
- La struttura garantisce resistenza alle sostanze corrosive, alle basse ed alte temperature ed agli urti anche sugli angoli

~~€ 387,54~~ **€ 271,00**

DESCRIZIONE	ARTICOLO / MISURA	PZ
Pinza universale isolata	085 N 180	1
Giraviti isolati a croce PH	092 PH 1x100-2x125	2
Giraviti isolati a croce PZ	092 PZ 1X100-2x125	2
Giraviti isolati ad intaglio	092/0,5x3x75-0,8x4x100-1x5,5x125-1,2x6,5x150	4
Mini seghetto	201 S	1
Forbice per elettricisti	207 D	1
Cutter multiuso	220 B1	1
Giravite cercafase	322 F	1
Flessometro	981 C 5	1



**NEW**

Kg	7 Kg	mm	L. 465
			H. 352
			P. 255

## 001 TRH14

Cod. U00010115



**14**  
PEZZI

### Trolley con assortimento per elettrotecnica

- Due pannelli interni amovibili con elastici portautensili
- Vano inferiore con divisori amovibili e regolabili
- Doppia serratura con chiave
- Maniglia ergonomica rivestita in gomma
- 3 cerniere posteriori e doppio braccetto di tenuta coperchio in metallo
- Gusci in polipropilene ad alto spessore montati su un'intelaiatura di alluminio
- La struttura garantisce resistenza alle sostanze corrosive, alle basse ed alte temperature ed agli urti anche sugli angoli
- Maniglia telescopica in alluminio
- Ruote con cuscinetto a sfera integrato

~~€ 504,94~~ **€ 353,00**

DESCRIZIONE	ARTICOLO / MISURA	PZ
Pinza universale isolata	085 N 180	1
Giraviti isolati a croce PH	092 PH 1x100-2x125	2
Giraviti isolati a croce PZ	092 PZ 1X100-2x125	2
Giraviti isolati ad intaglio	092/0,5x3x75-0,8x4x100-1x5,5x125-1,2x6,5x150	4
Mini seghetto	201 S	1
Forbice per elettricisti	207 D	1
Cutter multiuso	220 B1	1
Giravite cercafase	322 F	1
Flessometro	981 C 5	1

 4,7 Kg	 L. 465 H. 352 P. 215
--	--



## 001 RV

Cod. U00010004

MAX  
  
20kg

### Valigia porta utensili in polipropilene ad alto spessore (vuota)

- Due pannelli interni amovibili con elastici portautensili
- Vano inferiore con divisori amovibili e regolabili
- Doppia serratura con chiave
- Maniglia ergonomica rivestita in gomma
- 3 cerniere posteriori e doppio braccetto di tenuta coperchio in metallo
- Gusci in polipropilene ad alto spessore montati su un'intelaiatura di alluminio
- La struttura garantisce resistenza alle sostanze corrosive, alle basse ed alte temperature ed agli urti anche sugli angoli

~~€ 241,00~~ € 169,00



Anti corrosione





Resistente agli urti



Resistente alle alte e basse temperature



 6 Kg	 L. 465 H. 352 P. 255
--	--



## 001 TRV

Cod. U00010005

MAX  
  
20kg

### Valigia trolley porta utensili in polipropilene ad alto spessore (vuota)

- Due pannelli interni amovibili con elastici portautensili
- Vano inferiore con divisori amovibili e regolabili
- Doppia serratura con chiave
- Maniglia ergonomica rivestita in gomma
- 3 cerniere posteriori e doppio braccetto di tenuta coperchio in metallo
- Gusci in polipropilene ad alto spessore montati su un'intelaiatura di alluminio
- La struttura garantisce resistenza alle sostanze corrosive, alle basse ed alte temperature ed agli urti anche sugli angoli
- Maniglia telescopica in alluminio
- Ruote con cuscinetto a sfera integrato

~~€ 356,00~~ € 249,00



Anti corrosione



Resistente agli urti



Resistente alle alte e basse temperature





**Kg** 8 Kg **mm** L. 460  
H. 155  
P. 370

## 002 ME 20

Cod. U00020002

**20**  
PEZZI

### Valigia con assortimento per elettrotecnica

- Valigia con struttura in profilato di Alluminio e rinforzi in metallo
- Doppia cerniera di chiusura in metallo con serratura (chiave inclusa)
- Maniglia con protezione in materiale plastico
- 3 pannelli portautensili interni con elastici di tenuta
- Sistema di bloccaggio del pannello basculante

~~€ 362,10~~ **€ 253,00**

DESCRIZIONE	ARTICOLO / MISURA	PZ
Pinza a becchi mezzotondi isolata	081 N 160	1
Pinza universale isolata	085 N 180	1
Tronchese diagonale isolato	087 N 160	1
Giraviti isolati a croce PH	092 PH 1x100-2x125	2
Giraviti isolati a croce PZ	092 PZ 1X100-2x125	2
Giraviti isolati ad intaglio	092/0,4x2,5x50-0,5x3x75-0,8x4x100-1x5,5x125-1,2x6,5x1501,2x8x150	6
Pinza regolabile	178 N 240	1
Mni seghetto	201 S	1
Forbice per elettricisti	207 D	1
Cutter multiuso	220 B1	1
Giravite cercafase	322 F	1
Martello	382/300	1
Flessometro	981 C 5	1

**USAG**  
Nautica



## 012 A

Cod. U00120002

**53**  
PEZZI

### Valigia nautica

- Valigia a tenuta ermetica che consente di tenere isolato il contenuto dall'acqua, dalla salsedine e dalla polvere
- Chiusura tramite 4 clip: 2 frontali e 2 laterali
- Maniglia ergonomica integrata

~~€ 570,31~~ **€ 388,00**

DESCRIZIONE	ARTICOLO / MISURA	PZ
Cricchetto	237 B 1/2"	1
Chiave candele	278 N 1/2" 16	1
Chiave candele	279 N 1/2" 16	1
Chiave a rullino	294 A 200-8"	1
Giravite INOX	A4X100ST 0,8X4X100	1
Giravite INOX	A5,5X100ST 1X5,5X125	1
Giravite INOX	AF6,5X150ST 1,2X6,5X150	1
Giravite INOX	AP1X100ST PH1	1
Giravite INOX	AP2X125ST PH2	1
Pinza a becchi mezzotondi	133 A 160	1
Pinza universale	150 A 180	1
Tronchese	188 A 160	1
Pinza regolabile	178 N 240	1
Forbice per elettricista	207 C	1
Prolunga	236 1/2" 250	1
Maniglia a T	240 1/2" N	1
Snodo cardanico	241 1/2"	1
Mazzuola	377/35	1
Spazzola per candele	993 C	1
Chiavi combinate	285/7-8-10-12-13-14-17-19	8
Chiavi a forchetta	252 NP 3/8X7/16 - 1/2x9/16 - 5/8x11/16	3
Coltello multiuso INOX	218 N	1
Serie chiavi maschio INOX	83SHST.JP9A 1,5÷10	9
Chiave filtro olio	443 B	1
Chiavi a bussola esagonali	235 1/2" N 10-12-13-14-17-19-22	7
Chiavi a bussola in pollici	235 1/2" PN 7/16 - 1/2 - 9/16 - 11/16 - 7/8	5



**Kg** 9 Kg **mm** L. 590  
H. 90  
P. 410



Guarnizione inserita nel perimetro della valigia

by **FACOM**

**GIRAVITI E CHIAVI MASCHIO IN ACCIAIO INOX**

**INOX**



Cassetti inferiori a estrazione totale montati su guide telescopiche



Pannelli forati e ante predisposti per l'alloggiamento degli utensili (anta doppia solo 502 A2)



Apertura a 180° delle due ante



Chiusura di sicurezza a serratura delle ante e dei cassetti



Kg	45 Kg	mm	L. 720
			H. 1000
			P. 280



## 502 A2

Cod. U05020004

### Armadio vuoto a 2 cassetti

- Fornito senza ganci e supporti
- Dimensioni aperto: 1380x515x1000 mm
- Dimensioni interne cassetto: 570x210x60 mm

**2**  
Cassetti

~~€ 910,00~~ **€ 637,00**



## 654 V

Cod. U06540000

### Armadio a tapparella

- Pannelli forati amovibili
- Tapparella in alluminio con serratura
- Struttura in lamiera d'acciaio con verniciatura anaforetica
- Possibilità di ancoraggio a parete o fissaggio sui banchi
- Ganci e supporti non inclusi nell'armadio vuoto

~~€ 1.064,00~~ **€ 745,00**

Kg	41 Kg	mm	L. 1420
			H. 820
			P. 190

## GAMMA BANCHI DA LAVORO

Resistenza statica del piano fino a 2.000 Kg (modello da 2 metri)

Piano di lavoro in lamiera d'acciaio spessore 2,5 mm con bordo anticaduta

Struttura rinforzata in lamiera verniciata



Ripiano di appoggio inferiore sempre incluso

Montanti maggiorati Larghezza 90 mm

Predisposizione per il fissaggio al pavimento



### VERSIONE CON PIANO IN LEGNO

La piana in multistrato da 25 mm è contenuta all'interno di un supporto rinforzato in lamiera d'acciaio.

### CASSETTO OPZIONALE



### 506 U130

Cod. U05060129Q

- Cassetto con guide per banchi 506 A
- Serratura con chiavi inclusa
- Dimensioni interne: 570x420x175 mm
- Compatibile con moduli portautensili

€ 109,00

**€ 76,30**



**COMPATIBILE CON TUTTI I BANCHI 506 A**





## 506 A1/1000

Cod. U05060001

- Dimensioni: 1.000x700x850 mm
- Peso: 55 kg

KG  
1000

LEGNO

~~€ 325,00~~ € 228,00

## 506 A2/1000

Cod. U05060011

- Dimensioni: 1.000x700x850 mm
- Peso: 50 kg

KG  
1000

ACCIAIO

~~€ 220,00~~ € 154,00



## 506 A1/1500

Cod. U05060002

- Dimensioni: 1.500x700x850 mm
- Peso: 69 kg

KG  
1500

LEGNO

~~€ 439,00~~ € 307,00

## 506 A2/1500

Cod. U05060012

- Dimensioni: 1.500x700x850 mm
- Peso: 63 kg

KG  
1500

ACCIAIO

~~€ 311,00~~ € 218,00



## 506 A1/2000

Cod. U05060003

- Dimensioni: 2.000x700x850 mm
- Peso: 93 kg

KG  
2000

LEGNO

~~€ 526,00~~ € 368,00

## 506 A2/2000

Cod. U05060013

- Dimensioni: 2.000x700x850 mm
- Peso: 85 kg

KG  
2000

ACCIAIO

~~€ 389,00~~ € 272,00

## PANNELLI FORATI

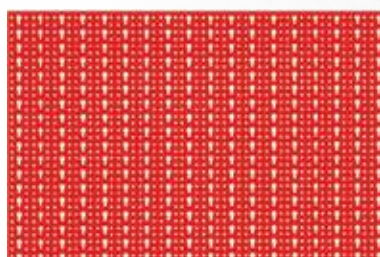

## MONTAGGIO A PARETE

## 501 PC 1000

Cod. U05010103Q

- Dimensioni: 1.000x800 mm

~~€ 86,50~~ € 60,50

## 501 PA 1500

Cod. U05010104Q

- Dimensioni: 1.500x800 mm

~~€ 144,00~~ € 101,00

## 501 PB 2000

Cod. U05010105Q

- Dimensioni: 2.000x800 mm

~~€ 166,00~~ € 116,00

**519 SKV5**  
Cod.U05190024Q



€ 10,90 **€ 7,60**

**519/200I**  
Cod.U05190715

**11**  
PEZZI



200 S · 207 A · 362 125-150 · 364 125 · 366 3x125-4x150 · 368 4x125 · 376 35 · 382 500 · 966 20

€ 131,30 **€ 92,00**

**519/252NA**  
Cod.U05190722

**8**  
PEZZI



252 N 6x7-8x9-10x11-12x13-14x15-16x17-18x19-20x22

€ 51,01 **€ 35,50**

**519/280T**  
Cod.U05190727

**8**  
PEZZI



280 T 2-2,5-3-4-5-6-8-10

€ 129,28 **€ 90,00**

**519/285B1**  
Cod.U05190786

**5**  
PEZZI



285 B 27-29-30-32-34

€ 121,00 **€ 84,50**

**519/092H**  
Cod.U05190771

**9**  
PEZZI



092 0,4x2,5x50-0,5x3x75 0,6x3,5x100-0,8x4x100-1x5,5x125-1,2x6,5x150 · 092 PH 0x75-1x100-2x125

€ 72,22 **€ 50,50**

**519/233C**  
Cod.U05190718

**12**  
PEZZI



233 1/2" NTX T40L-T45L-T55L-T70L · 233 1/2" NXZN 6L-8L-10L-12L · 234 1/2" N 5L2-6L-7L-8L

€ 178,77 **€ 125,00**

**519/252NB**  
Cod.U05190723

**4**  
PEZZI



252 N 21x23-24x27-25x28-30x32

€ 53,53 **€ 37,50**

**519/280TK**  
Cod.U05190787

**6**  
PEZZI



280 TK 2,5-3-4-5-6-8

€ 92,42 **€ 64,50**

**519/285KA1**  
Cod.U05190788

**12**  
PEZZI



285 KA 8-9-10-11-12-13-14-15-16-17-19

€ 196,60 **€ 138,00**

**519/127N**  
Cod.U05190716

**4**  
PEZZI



127 N 19÷60 · 127 PN 19÷60 · 128 N 19÷60 · 128 PN 19÷60

€ 90,40 **€ 63,50**

**519/234C**  
Cod.U05190720

**22**  
PEZZI



233 1/2" NTX T27-T30-T40-T45-T50-T55-T60 · 234 1/2" N 5-6-7-8-10-12-14-17 · 235 1/2" NTX E10-E12-E14-E16- E18-E20-E24

€ 221,19 **€ 155,00**

**519/276**  
Cod.U05190725

**8**  
PEZZI



276 CE 7-8-10-11-13-14-17-19

€ 232,30 **€ 163,00**

**519/283NA**  
Cod.U05190756

**8**  
PEZZI



283 N 6x7-8x9-10x11-12x13-14x15-16x17-18x19-20x22

€ 85,35 **€ 59,50**

**519/291N**  
Cod.U05190731

**11**  
PEZZI



291 N 8-10-11-12-13-14-15-16-17-18-19

€ 178,77 **€ 125,00**

**519/297**  
Cod.U05190733

**7**  
PEZZI



297 N 6x7-8x9-10x11-12x13-14x15-16x17-18x19

€ 239,37 **€ 168,00**

**519/150A**  
Cod.U05190712

**5**  
PEZZI



133 A 160 · 134 250 · 150 A 180 · 180 C 250 · 188 A 160

€ 133,32 **€ 93,00**

**519/235M**  
Cod.U05190719

**21**  
PEZZI



235 1/2 M 10-11-12-13-14-15-16-17-18-19-22-24 325 1/2 MLS 15-17-19-21-22 235 MC 4-5 235 MD 4-5

€ 110,09 **€ 77,00**

**519/280H**  
Cod.U05190730

**7**  
PEZZI



280 H 2-2,5-3-4-5-6-8

€ 56,86 **€ 39,00**

**519/285A1**  
Cod.U05190785

**25**  
PEZZI



285 6-7-8-9-10-11-12-13-14-15-16-17-18-19-22-24 280 S9 1,5÷10

€ 153,80 **€ 107,00**

**519/294**  
Cod.U05190732

**9**  
PEZZI



204 250 · 294 A 250 · 367 2x110-3x130-4x145-5x165-6x180-8x200 · 981 A2

€ 97,47 **€ 68,00**

**519/299**  
Cod.U05190777

**5**  
PEZZI



299 6-7-8-10-13 mm

€ 74,74 **€ 52,30**

**519/322H** 10 PEZZI  
Cod.U05190772



322 0,5x3x75-0,8x4x100-1x5,5x125-1,2x6,5x150-1,6x8x175 · 322 PH 0x75-1x100-2x125 · 322 N 0,8x4x30 · 322 NPH 2x30

€ 49,69 **€ 35,00**

**519/324B** 11 PEZZI  
Cod.U05190776



324 0,5x3x75-0,8x4x100-1x5,5x125-1,2x6,5x150 · 324 PH 1x75-2x100 · 324 N 0,8x4x35 · 324 NPH 2x35 · 092 0,8x4x100 · 092 PH 1x100 · 322 F

€ 75,38 **€ 53,00**

**519/324H** 10 PEZZI  
Cod.U05190774



324 0,5x3x75-0,8x4x100-1x5,5x125-1,2x6,5x150-1,2x8x200 · 324 PH 0x75-1x75-2x100 · 324 N 0,8x4x35 · 324 NPH 2x35

€ 63,32 **€ 44,30**

**519/324TX** 9 PEZZI  
Cod.U05190775



324 TX T6x50-T7x50-T8x50-T9x75 · 324 STX T10x75-T15x75-T20x100-T25x100-T30x125

€ 89,45 **€ 62,60**

**519/382F** 8 PEZZI  
Cod.U05190742



362 150 367 2x110-3x130-4x145-5x165 368 4x125 376 35-382F 500

€ 81,31 **€ 56,90**

**519/382** 2 PEZZI  
Cod.U05190741



376 35 · 382 500

€ 38,18 **€ 26,70**

**519/613AEA** 41 PEZZI  
Cod.U05190784 (237 A)



235 1/4" EN 4-4,5-5-5,5-6-7-8-9-10-11-12-13-14 · 236 1/4" 50-150 · 240 1/4" · 241 1/4" · 243 C 1/4" · 692 S11 · 692 STX/S11 · 684 1/4"-1/4"

€ 172,71 **€ 121,00**

**519/613AEB** 41 PEZZI  
Cod.U05190778 (237 B)



235 1/4" EN 4-4,5-5-5,5-6-7-8-9-10-11-12-13-14 · 236 1/4" 50-150 · 240 1/4" · 241 1/4" · 243 C 1/4" · 692 S11 · 692 STX/S11 · 684 1/4"-1/4"

€ 176,75 **€ 124,00**

**519/613CEA** 22 PEZZI  
Cod.U05190750 (237 A)



235 1/2" EN 10-11-12-13-14-15-16-17-18-19-20-21-22-24-27-30-32 · 236 1/2" 125-250 · 240 1/2" N · 241 1/2"

€ 212,10 **€ 148,00**

**519/613CEB** 22 PEZZI  
Cod.U05190780 (237 B)



235 1/2" EN 10-11-12-13-14-15-16-17-18-19-20-21-22-24-27-30-32 · 236 1/2" 125-250 · 240 1/2" N · 241 1/2"

€ 219,17 **€ 153,00**

**519/607CEA** 30 PEZZI  
Cod.U05190811 (237 A)



235 1/2" EN 8-34 · 236 1/2" 125-250 · 239 1/2" N · 240 1/2" N · 241 1/2"

€ 277,34 **€ 194,00**

**519/607CB** 30 PEZZI  
Cod.U05190812 (237 B)



235 1/2" N 8-34 · 236 1/2" 125-250 · 239 1/2" N · 240 1/2" N · 241 1/2"

€ 286,00 **€ 200,00**

**519/990** 5 PEZZI  
Cod.U05190754

Taglio mezzo dolce

990 M PA200 - PB200 - PC200 - PD200 - PE200

**519/990B** 5 PEZZI  
Cod.U05190755

Taglio bastardo

990 B PA200-PB200-PC200-PD200- PE200

**519/960** 7 PEZZI  
Cod.U05190753



207 A · 220 B1 · 960 · 966 20 · 974 · 978 A 200 · 981 C 3

€ 123,22 **€ 86,30**



€ 58,58 **€ 40,30**

**519/366** 7 PEZZI  
Cod.U05190740



351 200 · 362 125-150 · 364 125 · 366 3x125 · 4x150 · 368 4x125

€ 63,13 **€ 44,20**

**519/607AEA** 44 PEZZI  
Cod.U05190790 (237 A)



235 1/4" EN 4-14 · 235 1/4" EL 5-14 · 236 1/4" 50-100-150 · 240 1/4" · 241 1/4" · 243 C 1/4" · 660 · 660 E · 660 PH · 684 1/4"-1/4"

€ 243,07 **€ 170,00**

**519/607AEB** 44 PEZZI  
Cod.U05190791 (237 B)



235 1/4" EN 4-14 · 235 1/4" EL 5-14 · 236 1/4" 50-100-150 · 240 1/4" · 241 1/4" · 243 C 1/4" · 660 · 660 E · 660 PH · 684 1/4"-1/4"

€ 248,77 **€ 174,00**

**519/613BEA** 21 PEZZI  
Cod.U05190747 (237 A)



235 3/8" E 6-7-8-9-10-11-12-13-14-15-16-17-18-19-21-22 · 236 3/8" 125-250 · 240 3/8" N · 241 3/8"

€ 173,72 **€ 122,00**

**519/613BEB** 21 PEZZI  
Cod.U05190779 (237 B)



235 3/8" E 6-7-8-9-10-11-12-13-14-15-16-17-18-19-21-22 · 236 3/8" 125-250 · 240 3/8" N · 241 3/8"

€ 181,80 **€ 127,00**

**519/613CEA** 22 PEZZI  
Cod.U05190750 (237 A)



235 1/2" EN 10-11-12-13-14-15-16-17-18-19-20-21-22-24-27-30-32 · 236 1/2" 125-250 · 240 1/2" N · 241 1/2"

€ 212,10 **€ 148,00**

**519/613CEB** 22 PEZZI  
Cod.U05190780 (237 B)



235 1/2" EN 10-11-12-13-14-15-16-17-18-19-20-21-22-24-27-30-32 · 236 1/2" 125-250 · 240 1/2" N · 241 1/2"

€ 219,17 **€ 153,00**

**519/613CB** 22 PEZZI  
Cod.U05190783 (237 B)



235 1/2" E 10-11-12-13-14-15-16-17-18-19-20-21-22-24-27-30-32 · 236 1/2" 125-250 · 240 1/2" N · 241 1/2"

€ 219,17 **€ 153,00**

**519/607CA** 30 PEZZI  
Cod.U05190810 (237 A)



235 1/2" N 8-34 · 236 1/2" 125-250 · 239 1/2" N · 240 1/2" N · 241 1/2"

€ 276,20 **€ 193,00**

**519/607CEB** 30 PEZZI  
Cod.U05190813 (237 B)



235 1/2" EN 8-34 · 236 1/2" 125-250 · 239 1/2" N · 240 1/2" N · 241 1/2"

€ 278,14 **€ 195,00**



519/127N

519/150A

519/285A1



519/324H

519/382F

519/613CEA

## 495 BA

Cod. U04950002

**74**  
PEZZI

**Assortimento manutenzione BASE - 2 cassette**

~~€ 731,41~~ **€ 512,00**

DESCRIZIONE	ART	PZ
Pinze per anelli elastici	519/127N	4
Pinza universale, pinza regolabile, tronchese, pinza becchi lunghissimi, pinza grip	519/150A	5
Chiavi combinate, chiavi maschio esagonali	519/285A1	25
Giraviti	519/324H	10
Martello, mazzuola, scalpello, bulino, cacciaspine	519/382F	8
Bussole esagonali, cricchetto (237 A 1/2") e accessori 1/2"	519/613CEA	22



519/127N

519/150A

519/276



519/285A1

519/324H

519/324TX

519/613CEA

## 495 A1

Cod. U04950011

**83**  
PEZZI



**Assortimento AUTO - 3 cassette**

~~€ 995,21~~ **€ 697,00**

DESCRIZIONE	ART	PZ
Pinze per anelli elastici	519/127N	4
Pinza universale, pinza regolabile, tronchese, pinza becchi lunghissimi, pinza grip	519/150A	5
Chiavi a T snodate esagonali	519/276	8
Chiavi combinate, chiavi maschio esagonali	519/285A1	25
Giraviti a taglio e croce PH	519/324H	10
Giraviti TORX	519/324TX	9
Bussole esagonali, cricchetto (237 A 1/2") e accessori 1/2"	519/613CEA	22

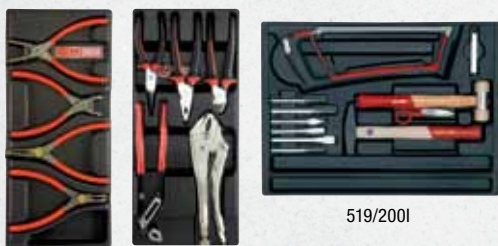

519/127N

519/150A

519/200I



519/285A1

519/294

519/324H

519/613CEA

## 495 I1

Cod. U04950021

**86**  
PEZZI



**Assortimento INDUSTRIA - 3 cassette**

~~€ 893,31~~ **€ 625,00**

DESCRIZIONE	ART	PZ
Pinze per anelli elastici	519/127N	4
Pinza universale, pinza regolabile, tronchese, pinza becchi lunghissimi, pinza grip	519/150A	5
Taglio, martelli, scalpelli	519/200I	11
Chiavi combinate, chiavi maschio esagonali	519/285A1	25
Chiave a rullino, cesoia, flessometro e cacciaspine	519/294	9
Giraviti a taglio e croce PH	519/324H	10
Bussole esagonali, cricchetto (237 A 1/2") e accessori 1/2"	519/613CEA	22

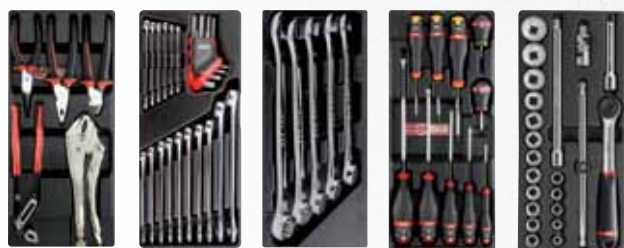

519/150A 519/285A1 519/285B1 519/324H 519/613CEA



519/127N 519/2001 519/276



519/280T 519/234C

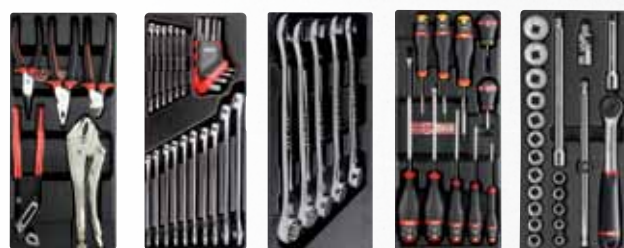

519/150A 519/285A1 519/285B1 519/324H 519/613CEA



519/127N 519/283NA 519/990 519/294



519/2001

**495 A2**  
Cod. U04950012

**120**  
PEZZI



**Assortimento AUTO TOP 5 Cassetti**

~~€ 1.514,99~~ **€ 1.060,00**

DESCRIZIONE	ART/MIS.	PZ
Pinze per anelli elastici	519/127N	4
Pinza universale, pinza regolabile, tronchese, pinza becchi lunghissimi, pinza grip	519/150A	5
Taglio, martelli, scalpelli	519/2001	11
Chiavi a bussola 1/2" TORX, con inserti esagonali e TORX	519/234C	22
Chiavi a T snodate esagonali	519/276	8
Chiavi maschio a T	519/280T	8
Chiavi combinate, chiavi maschio esagonali	519/285A1	25
Chiavi combinate	519/285B1	5
Giraviti a taglio e croce PH	519/324H	10
Bussole esagonali, cricchetto (237 A 1/2") e accessori 1/2"	519/613CEA	22

**495 I2**  
Cod. U04950022

**104**  
PEZZI



**Assortimento INDUSTRIA TOP 4 Cassetti**

~~€ 1.174,54~~ **€ 822,00**

DESCRIZIONE	ART	PZ
Pinze per anelli elastici	519/127N	4
Pinza universale, pinza regolabile, tronchese, pinza becchi lunghissimi, pinza grip	519/150A	5
Taglio, martelli, scalpelli	519/2001	11
Chiavi doppie poligonali	519/283NA	8
Chiavi combinate, chiavi maschio esagonali	519/285A1	25
Chiavi combinate	519/285B1	6
Chiave a rullino, cesoia, flessometro e cacciaspine	519/294	9
Giraviti a taglio e croce PH	519/324H	10
Bussole esagonali, cricchetto (237 A 1/2") e accessori 1/2"	519/613CEA	22
Lime a taglio mezzodolce	519/990	5

## NUOVO CARRELLO 516 START

**SERRATURA POSTERIORE**  
per evitare rotture accidentali



**800 KG**

**PIANO DI LAVORO IN ABS**  
con doppia maniglia integrata



**NEW**

**CASSETTI**

montati su guide  
telescopiche e con tappetini  
interni in gomma antiolio.  
Portata MAX:  
20 Kg (H=60-130 mm)  
30 Kg (H=200 mm)

**PORTA  
FLACONI**





**MANIGLIE IN ABS**  
con aggancio rapido



**RUOTE**  
in gomma antiolio Ø 125 mm

748 mm

 54 Kg	 mm	L. 748 H. 970 P. 515
---	--	----------------------------

**516 SP6V**  
Cod. U05160006

**6**  
CASSETTI

**3**  
MODULI

**Carrello Start - 6 cassetti (vuoto)**

- Dimensioni interne:
  - 3 cassetti 570x420x60 mm
  - 2 cassetti 570x420x130 mm
  - 1 cassetto 570x420x200 mm

**START 516**

~~€ 570,00~~

**€ 375,00**

## NUOVO CARRELLO 516 START EXTRA-LARGE

**CHIUSURA**  
di sicurezza a serratura  
centralizzata

**MANIGLIA**  
In acciaio, resistente  
e compatta



**PIANO DI LAVORO**  
in ABS ad alta resistenza



**NEW**

**CASSETTI**  
montati su guide  
telescopiche.  
Portata MAX:  
20 Kg (H=60-130 mm)  
30 Kg (H=200 mm)



**RUOTE**  
in gomma antiolio Ø 125 mm



90 Kg	mm	L. 995
		H. 987
		P. 500

**516 S6XLV**  
Cod. U05160010

**6**  
CASSETTI

**4**  
MODULI

**Carrello Start XL - 6 cassetti (vuoto)**

- Dimensioni interne:
  - 3 cassetti 760x420x60 mm
  - 2 cassetti 760x420x130 mm
  - 1 cassetto 760x420x200 mm

**START 516**

~~€ 700,00~~ **€ 490,00**

## USAG Racing 519



Inquadra il codice QR o vai sul canale YouTube USAG per guardare il video dimostrativo



**519 R5/3V**

Cod. U05190413

KG 900

3

MODULI

**Carrello Racing 5 cassetti (vuoto)**

- 2 cassetti: H 60 mm
- 2 cassetti: H 130 mm
- 1 cassetto: H 270 mm

~~€ 871,00~~ **€ 610,00**

70 Kg L. 774  
H. 971  
P. 546



**519 R6/3V**

Cod. U05190414

KG 900

3

MODULI

**Carrello Racing 6 cassetti (vuoto)**

- 4 cassetti: H 60 mm
- 1 cassetto: H 130 mm
- 1 cassetto: H 270 mm

~~€ 945,00~~ **€ 662,00**

72 Kg L. 774  
H. 971  
P. 546



**519 R7/3V**

Cod. U05190415

KG 900

3

MODULI

**Carrello Racing 7 cassetti (vuoto)**

- 5 cassetti: H 60 mm
- 1 cassetto: H 130 mm
- 1 cassetto: H 200 mm

~~€ 1.036,00~~ **€ 725,00**

74 Kg L. 774  
H. 971  
P. 546



**519 R8/3V**

Cod. U05190416

KG 900

3

MODULI

**Carrello Racing 8 cassetti (vuoto)**

- 6 cassetti: H 60 mm
- 2 cassetti: H 130 mm

~~€ 1.127,00~~ **€ 789,00**

76 Kg L. 774  
H. 971  
P. 546



**519 R6/4V**

Cod. U05190419

KG 1000

4

MODULI

**Carrello Racing 6 cassetti (vuoto)**

- 4 cassetti: H 60 mm
- 1 cassetto: H 130 mm
- 1 cassetto: H 270 mm

~~€ 1.100,00~~ **€ 770,00**

83 Kg L. 964  
H. 971  
P. 546



**519 R6/5V**

Cod. U05190420

KG 1100

5

MODULI

**Carrello Racing 6 cassetti (vuoto)**

- Ruote in gomma antiolio (ø 160 mm)
- 3 cassetti: H 60 mm
- 2 cassetti: H 130 mm
- 1 cassetto: H 200 mm

~~€ 1.418,00~~ **€ 993,00**

94 Kg L. 1154  
H. 1000  
P. 546

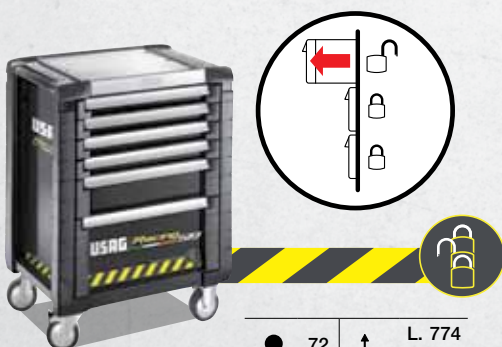

**519 R6S/3V**

Cod. U05190491

KG 900

3

MODULI

**Carrello Racing con sistema antiribaltamento 6 cassetti (vuoto)**

- Sistema antiribaltamento che permette di aprire un solo cassetto per volta
- Stesse caratteristiche della versione 519 R6/3V a 6 cassetti.

~~€ 1.189,00~~ **€ 832,00**

72 Kg L. 774  
H. 971  
P. 546



**USAG** *Sprint 518*



## SPRINT: QUALITÀ E CONVENIENZA!



**Kg** 70 Kg L. 790  
H. 970  
P. 520

**518 S5V**  
Cod. U05180103

KG  
900

**3**  
MODULI

**Carrello Sprint - 5 cassetti (vuoto)**

- Dimensioni interne:
  - 2 cassetti 570x420x60 mm
  - 2 cassetti 570x420x130 mm
  - 1 cassetto 570x420x270 mm

~~€ 594,00~~ **€ 416,00**



**Kg** 72 Kg L. 790  
H. 970  
P. 520

**518 S6V**  
Cod. U05180104

KG  
900

**3**  
MODULI

**Carrello Sprint - 6 cassetti (vuoto)**

- Dimensioni interne:
  - 4 cassetti 570x420x60 mm
  - 1 cassetto 570x420x130 mm
  - 1 cassetto 570x420x270 mm

~~€ 685,00~~ **€ 480,00**



**Kg** 74 Kg L. 790  
H. 970  
P. 520

**518 S7V**  
Cod. U05180105

KG  
900

**3**  
MODULI

**Carrello Sprint - 7 cassetti (vuoto)**

- Dimensioni interne:
  - 5 cassetti 570x420x60 mm
  - 1 cassetto 570x420x130 mm
  - 1 cassetto 570x420x270 mm

~~€ 777,00~~ **€ 544,00**

## ACCESSORI CARRELLI



**519 RA1**  
Cod. U05190207

**Portarifiuti**  
per Racing, Sprint  
e Booster

~~€ 84,00~~ **€ 58,80**



**519 RA2**  
Cod. U05190208

**Portadocumenti**  
per Racing, Sprint e  
Booster

~~€ 46,60~~ **€ 32,50**



**519 RA3**  
Cod. U05190209

**Pannello  
superiore**  
per Racing (3 moduli)

~~€ 133,00~~ **€ 93,00**



**519 RA4**  
Cod. U05190210

**Portarotolo**  
per Racing, Sprint  
e Booster

~~€ 47,80~~ **€ 33,50**



**519 RA5**  
Cod. U05190211

**Portaflaconi**  
per Racing, Sprint  
e Booster

~~€ 73,50~~ **€ 51,50**



**504 S**

Cod. U05040003

KG  
200

**3**  
RIPIANI

### Carrello a 3 ripiani multiuso

- Con tappeti in gomma
- Maniglia in acciaio per una maggiore manovrabilità
- Due ruote pivotanti (Ø 100 mm) e due ruote fisse (Ø 100 mm)
- Fornito smontato

~~€ 156,00~~

**€ 109,00**



18 Kg



L. 750  
H. 950  
P. 450



94 Kg



L. 1154  
H. 1000  
P. 546

**513 B6V**

Cod. 05130096

KG  
1100

**3**  
MODULI

### Carrello Booster - 6 cassetti (vuoto)

- Armadietto portaoggetti con anta richiudibile
- Ruote in gomma antiolio (Ø 160 mm)
- Dimensioni interne:
  - 4 cassetti 570x420x60 mm
  - 1 cassetto 570x420x130 mm
  - 1 cassetto 570x420x270 mm
- Vano laterale: 380x400x720 mm

~~€ 1.417,00~~

**€ 992,00**



**514 B6V**

Cod. U05140001

KG  
1000

**3**  
MODULI

### Banco da lavoro mobile BULL - 6 cassetti (vuoto)

- Piano di lavoro in legno multistrato
- Portata massima cassetti: 20 Kg
- Dimensioni interne:
  - 3 cassetti 570x420x60 mm
  - 2 cassetti 570x420x130 mm
  - 1 cassetto 570x420x270 mm
- Vano laterale: 380x704x524 mm

~~€ 1.802,00~~

**€ 1.261,00**



128 Kg



L. 1.212  
H. 995  
P. 670

### UN BANCO DA LAVORO CON LA MOBILITÀ DI UN CARRELLO.

Il sistema integrato nella maniglia, aziona i supporti di bloccaggio e permette di utilizzare le 4 ruote per spostare con facilità il banco da lavoro.



## S3 SRA



**TOMAIA TRASPIRANTE**  
Microfibra + Mesh

**PUNTALE**  
in composito  
resistenza 200 joule

**SUOLA**  
polietilene e gomma anti olio

 **EN ISO 20345: 2011**



**CALZATA**



**METAL FREE**

**FLESSIBILITÀ E LEGGEREZZA**

Es. Taglia 43 solo 510 g

### 3500 S3A

#### Scarpe antinfortunistiche METAL FREE

- Tomaia in microfibra+mesh impermeabile
- Fodera mesh e Nylon traspirante
- Suola in polietilene e gomma resistente all'olio
- Suoletta in materiale composito
- Sottopiede anatomico in polietilene
- Puntale in composito, resistenza 200 joule
- Resistenza allo scivolamento SRA
- Resistenza al calore fino a 200 °C
- Modello adatto a tutte le stagioni

~~€ 112,00~~ **€ 78,30**

Official Licensed Merchandise by



TAGLIA	CODICE
36	U35000100
37	U35000101
38	U35000102
39	U35000103
40	U35000104
41	U35000105
42	U35000106
43	U35000107
44	U35000108
45	U35000109
46	U35000110
47	U35000111



## 233 1/2 MXZN

Cod. U02332182



### Chiave a bussola XZN per mozzi ruote

- Per il montaggio/smontaggio della vite sull'albero calettato al mozzo dell'asse posteriore
- Acciaio speciale altamente legato al Nichel Cromo Molibdeno
- Esecuzione fosfatata

~~€ 15,30~~

**€ 11,00**



## 270 B/C3

Cod. U02700105

**3**  
PEZZI

### Serie di 3 bussole per cerchi in lega con protezione in teflon

- 270 B/17-19-21 mm
- Fornita in cassetta di plastica

~~€ 93,51~~

**€ 65,00**



## 270 BM

Cod. U02700140



Mercedes-Benz

### Chiave a bussola per dadi ruota Mercedes

- Indispensabili per allentare e serrare il nuovo profilo delle viti Mercedes
- Protezione in teflon che riduce il rischio di danneggiamento del cerchio in lega
- Adatta per i modelli: Classe C e GLK (W204), Classe E (W211, W212, W207), Classe SLK (W172), Classe ML (W164, W166), Classe CL (W216), Classe S (W221, W222)

~~€ 11,40~~

**€ 8,00**



## 2000 A

Cod. U20000100

### Letto sottoscocca 6 ruote

- Cuscino poggiatesta in vinile resistente agli idrocarburi.
- Struttura in materiale plastico resistente agli idrocarburi, lavabile
- Due vaschette porta utensili laterali
- Maniglia di movimentazione
- Carico massimo ammissibile: 150 Kg
- Altezza massima da terra: 115mm
- Fornito con 6 ruote in gomma pivottanti Ø 80mm (da montare)

~~€ 102,00~~

**€ 69,50**

# TPMS

## Tire Pressure Monitoring System



**1,4÷10 Nm**

Universale per tutti i tipi di valvole TPMS



**425 TPMS**

Cod. U04250005

**10**  
PEZZI

Kit di utensili per montare e smontare le valvole pneumatici con sistema di controllo della pressione



~~€ 254,00~~ **€ 185,00**

**Kg** 4,1 Kg  
L. 230  
H. 627  
P. 302



**1785 B**

Cod. U17850005

**9,5**  
LITRI

**Estrattore fluidi**

- Capacità: -1÷4 bar
- Per l'estrazione di oli lubrificanti da motore, freni, cambio e liquidi antigelo da qualsiasi tipo di veicolo
- Utilizzo manuale tramite leva di pompaggio o pneumatico con ausilio dell'aria compressa



~~€ 191,00~~ **€ 134,00**

### CARATTERISTICHE TECNICHE

Alimentazione con aria compressa	5÷8 bar
Range temperatura liquidi aspirati	1÷100 °C
Capacità serbatoio	9,5 litri
Accessori contenuti	1 tubo principale 1500 x Ø 16 mm - 4 tubi di aspirazione: 400 x Ø 9,5 mm, 700 x Ø 6 mm, 850 x Ø 7, 700 x Ø 6



**1881 S22**

Cod. U18810082

**30**  
PEZZI

Kit universale per lo smontaggio e il montaggio delle ghiera pulegge alternatori

- Fornito in cassetta di plastica



~~€ 115,00~~ **€ 80,50**



Inquadra il codice QR o vai sul canale YouTube USAG per guardare il video dimostrativo

## KIT PER SILENTBLOCK

**1350 F1**

Cod. U13500001



### Kit estrazione/introduzione Silentblock per FIAT/FORD/OPEL

- Utilizzabile con: FIAT Panda (4x4 - Cross - Metano), FIAT 500, FORD Ka, OPEL Adam
- Necessario per il Silentblock del ponte posteriore
- Utilizzabile direttamente sul veicolo
- Opera in sicurezza senza danneggiare i braccetti Classe S (W221, W222)

~~€ 271,00~~

**€ 190,00**

**NEW**



### APPLICAZIONI:

SILENTBLOCK Ø	MARCA	MODELLO
Ø 45 mm		Panda (4x4 - Cross - Metano)
Ø 45 mm		500
Ø 54 mm		Ka
Ø 54 mm		Adam



**885 E**

Cod. U08850003

### Kit per rimozione elettrodo candele di preriscaldamento DIESEL

- Permette la rimozione degli elettrodi spezzati senza smontare la testata
- Specifico per i motori CITROËN, FORD, MAZDA, PEUGEOT, SUZUKI, TOYOTA, VOLVO
- Per candele con filettatura M8x1 - M9x1 - M10x1 - M10x1,25
- Fornito in valigetta di plastica

~~€ 408,00~~

**€ 305,00**



Zona di rottura

CITROËN: Xsara, C2, C3, C4, C5  
 FORD: C-MAX, Fiesta, Focus, Fusion  
 MAZDA: 2  
 PEUGEOT: 107, 206, 207, 307, 407, 1007

SUZUKI: Liana  
 TOYOTA: Aygo  
 VOLVO: S40, V50



## EFFETTO CRICCHETTO

- Rapidità e facilità d'uso anche in spazi ridotti

## SERRAGGIO AUTOMATICO DEL NASTRO

- Velocizzazione dell'operazione
- Ottimizzazione dell'effetto cricchetto



	7 Kg		L. 620
			H. 80
			P. 490



Permettono il riserraggio alla coppia originale di smontaggio (valore indicato sulla campana di plastica)



## 443 N

Cod. U04430005



### Chiave automatica a ripresa rapida per filtri olio (autovetture)

- Regolazione automatica del nastro
- Leva di incremento potenza di serraggio per un grip perfetto sul filtro
- Ganasce snodate per il trattenimento del filtro e l'effetto cricchetto
- Nastro in acciaio inox
- Impugnatura (160 mm) in materiale plastico ad alta resistenza (idrocarburi, urti)

~~€ 87,00~~

**€ 61,00**

## 446 S28

Cod. U04461204



**30**  
PEZZI

### Assortimento di 30 chiavi per filtri olio

- Serie composta da 28 chiavi a tazza con quadro di manovra da 3/8", 1 adattatore da 3/8" a 1/2", 1 chiave autoserrante (capacità 65÷120 mm) con quadro di manovra da 3/8"
- Il set è adatto per la maggior parte dei filtri olio montati sui veicoli circolanti
- Misure delle 28 chiavi a tazza Ø x N°lati:  
66/6 - 65/14 - 65/67 - 68/14 - 73/14 - 74/15 - 74/76 - 75/77 - 76/12 - 76/14 - 76/30 - 76/8 - 78/15 - 80/15 - 80/82 - 86/16 - 86/18 - 90/15 - 92/10 - 93/15 - 93/36 - 93/45 - 95/15 - 96/18 - 100/15 - 106/15 - 108/15 - 108/18
- Corpo in acciaio al carbonio esecuzione brunita
- Fornite con valigetta in materiale plastico, dotata di maniglia per il trasporto e clip di chiusura

~~€ 168,00~~

**€ 118,00**



## 446 DA/SE6

Cod. U04461104



**6**  
PEZZI

### Serie di 6 chiavi per coperchio filtro olio

- 1 chiave 14 tacche Ø 76 mm
- 1 chiave 14 tacche Ø 102 mm
- 1 chiave 16 tacche Ø 76 mm
- 1 chiave 16 tacche Ø 88 mm
- 1 chiave 18 tacche Ø 66 mm
- 1 chiave 18 tacche Ø 96 mm
- Quadro di manovra 3/8"

~~€ 178,00~~

**€ 125,00**



## IN ALLUMINIO



27 mm

- Dimensioni profilo: Ø 64,5 mm x 14 lati.
- Dimensioni d'ingombro (Øxh): 80x49 mm.



27 mm

- Dimensioni profilo: Ø 64,5 mm x 14 lati.
- Dimensioni d'ingombro (Øxh): 86x49 mm.



3/8"



60÷80 mm

80÷100 mm



1/2"



### 446 DT/S2

Cod. U04461203

2 PEZZI

#### Serie di 2 chiavi per coperchi filtro olio modelli Giapponesi

- Riduce i rischi di danneggiamento dei coperchi filtri.
- Utilizzabili anche in serraggio con chiave dinamometrica
- Corpo in alluminio fosfatato.

~~€ 49,50~~

**€ 34,50**



Inquadra il QR code per scaricare la tabella delle applicazioni del 446 DT/S2 o vai sul sito [www.usag.it](http://www.usag.it)



Specifiche per smontare i coperchi dei filtri olio a immersione dei motori Toyota, Lexus, Daihatsu, Subaru



Utilizzabili anche per rimuovere le cartucce dei filtri olio Toyota

### 446 E/SE2

Cod. U04460015

2 PEZZI

#### Serie di 2 chiavi autoserranti per filtri olio

- 446 E/60÷80-80÷100 mm

~~€ 137,00~~

**€ 96,00**



### 446 M

Cod. U04460011

#### Chiavi per filtro gasolio multijet

- Chiave con attacco quadro di manovra da 1/2" per chiave dinamometrica
- Adattatore per inserimento filtro nella morsa da banco

~~€ 67,50~~

**€ 47,30**







## 870 C

Cod. U08700006

### Pinza per raccordi rapidi carburante

- Per veicoli a benzina e diesel
- Impugnature ergonomiche bimalteriali
- Lunghezza: 175 mm

~~€ 54,50~~

**€ 38,20**

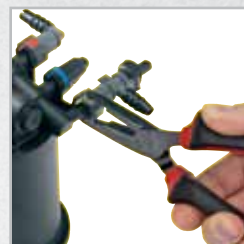

## 871 C

Cod. U08719005P

### Pinza per fascette automatiche CLIC

- Testa triassiale per lavorare in tutte le posizioni
- Permette di aprire o chiudere le fascette automatiche presenti sui circuiti del carburante, dei collettori d'aspirazione e dei circuiti idraulici

~~€ 64,50~~

**€ 45,20**



**3 POSIZIONI  
DI LAVORO**



Max.  
Ø 20 mm

## 871 D

Cod. U08710001

### Pinza per anelli stringitubo a presa frontale/laterale

- Possibilità di aggancio frontale o laterale
- Ganasce con superficie di presa zigrinata
- Molla interna di richiamo
- Impugnature ergonomiche antiscivolo

~~€ 45,10~~

**€ 31,60**

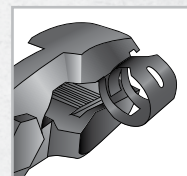

**2 IN 1**



## 884 C/S6

Cod. U08841000

### Serie di 6 chiavi per raccordi tubi iniettori

- Per montaggio/smontaggio dei raccordi tubi iniettori
- Lunghezza: 98 mm
- Misure: 12-14-16-17-18-19

~~€ 107,00~~

**€ 75,00**



**6  
PEZZI**



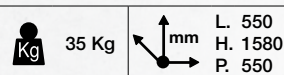

## 263 RA

Cod. U02631600

CAPACITA'  
**80 L**

### Recuperatore olio

- Modello a caduta
- Capacità del serbatoio 80 litri
- Indicatore laterale per la verifica del livello olio nel serbatoio
- Coppa superiore simmetrica in acciaio da 13,5 litri
- Diametro coppa 550 mm
- Griglia in materiale plastico all'interno della coppa
- Asta telescopica in acciaio diametro 38 mm fissata con ghiera in metallo
- Sistema di svuotamento del serbatoio con aria compressa (max 3,5 bar)
- Tubo di scarico flessibile lungo 1800 mm
- Altezza regolabile da 1140 a 1580 mm
- 4 ruote pivottanti: Ø 70 mm

~~€ 507,00~~ **€ 279,00**

## COMPATIBILE CON LIQUIDO FRENI DOT ED ANTIGELO



Blocco di giunzione in metallo con guarnizione interna in EPDM



Tubo esterno antiurto in poliuretano per il controllo del serbatoio



Attacco per il recuperatore d'olio



## 263/S16

Cod. U02631400

**16**  
PEZZI

### Kit per tappi olio (16 pz)

- Bussole magnetiche per il trattenimento dei tappi
- Leva snodata con quadro 3/8" per la massima accessibilità
- Sistema salva mani integrato nella leva snodata: evita che l'olio cada sulle mani durante l'operazione
- 1 chiave snodata con coppetta
- 2 inserti    ⌀ 8-10 mm
- 6 inserti    ⌀ 8-10-12-13-14-17 mm
- 6 bussole    ● 13-14-17-18-19-21 mm
- 1 inserto    ⚙ T45



~~€ 156,00~~ **€ 109,00**



#### CARATTERISTICHE TECNICHE

Attacco filettatura	M18
Livello sonoro	78 Db
Lunghezza totale	630 mm
Peso	2,8 Kg
Pressione di esercizio	6,2 bar
Attacco filettato	1/4"



## 400 P

Cod. U04000010

### Aspiratore pneumatico ammaccature

- Ideale per eliminare ammaccature da parti scatolate senza la necessità di rivernicare
- Fornito con 3 ventose (Ø 75-100-125 mm), in valigetta in materiale plastico dotata di maniglia per il trasporto e clip di chiusura

~~€ 170,00~~

**€ 119,00**



Indicatore temperatura a LED



Accessori inclusi

#### 2 MODALITÀ:

- 1 250 l/min - 50°÷400°C
- 2 500 l/min - 50°÷600°C

## 391

Cod. U03910001

MAX  
600  
GRADI

2000  
WATT

### Pistola termica digitale

- Modello elettronico con controllo della temperatura e del volume d'aria mediante display digitale
- Utilizzabile con gli ugelli 391 A÷F
- Possibilità di impostazione dei programmi
- Dotata di sistema di raffreddamento

~~€ 177,00~~

**€ 124,00**



**NEW**

## 426 D/S4

Cod. U04260005

**4**  
PEZZI

### Scalpelli separatori in plastica

- Per separare i carter della cinghia di distribuzione, testata motore, cinghia di trasmissione etc.
- Evita di danneggiare la superficie di tenuta delle guarnizioni.
- Utilizzabili con martello.

~~€ 22,70~~

**€ 17,00**



## 426 B/S5

Cod. U04260006

**5**  
PEZZI

### Kit di 5 utensili per componenti in plastica

- Permettono la rimozione di modanature, pioli, parti cruscotto, rivestimenti portiere, ecc.
- Non rovinano le parti in plastica, guarnizioni, carrozzeria

~~€ 26,40~~

**€ 19,80**



## 426 C/S4

Cod. U04260007

**5**  
PEZZI

### Kit di 4 raschietti multiuso in plastica

- Per la rimozione di contrappesi, silicone, modanature etc
- Non rovinano le parti in plastica o verniciate, le guarnizioni, la ceramica
- Utilizzabili con martello
- Riaffilabili con lima
- Lunghezza 270mm
- Larghezza lame: 19-22-25-38mm

~~€ 28,30~~

**€ 21,20**



Inquadra il codice QR  
o vai sul canale YouTube USAG  
per guardare il video dimostrativo



## 447 T

Cod. U04470101

### Smonta ammortizzatori pneumatico

- Ideale per autovetture
- Sistema di autolivellamento dei bracci superiori: adatto anche a molle coniche e disassate
- Boccole autolubrificanti: nessuna operazione di lubrificazione e/o ingrassaggio sulle colonne di scorrimento
- Fornito con due staffe inferiori 447 TC1 (78÷130 mm) e 447 TC2 (125÷205 mm), morsa 447 TA e morsetti superiori universali 447 TB1

~~€ 1.628,00~~

**€ 999,00**

#### CARATTERISTICHE TECNICHE

Potenza compressione	735 Kg (6 bar) - 1226 Kg (10 bar)
Pressione di esercizio	6÷10 bar
Corsa del pistone	420 mm
Cilindro	Doppio in lega d'alluminio e resina al nylon

**Kg** 60 Kg

**mm**  
L. 470  
H. 1390  
P. 450



**POTENZA DI COMPRESSIONE  
735 KG (6 BAR) - 1226 KG (10 BAR)**



## CONFORMITA' ALLA DIRETTIVA MACCHINE

Gli smontammortizzatori pneumatici USAG sono progettati per rispondere pienamente alla Direttiva Macchine 2006/42/CE. Alcune funzionalità della macchina sono state impostate perché l'operatore possa lavorare in totale sicurezza:

- Protezione frontale di sicurezza
- Dispositivo di arresto del pistone in caso di apertura della protezione frontale
- Velocità limitata: sempre inferiore ai 10 cm/sec
- Sistema di blocco delle ganasce e del pistone in caso di interruzione dell'alimentazione dell'aria

## UTILIZZABILI SULLA MAGGIOR PARTE DEI VEICOLI, COMPRESI MOTOCICLI



**468 M2**

**3 REGOLAZIONI**



Ø 18÷53 mm



Ø 41÷76 mm



Ø 54÷90 mm



**468 M1**

**3 REGOLAZIONI**



Ø 9,5÷23,5 mm



Ø 23,5÷36,5 mm



Ø 36,5÷50 mm

### 468 M

#### Utensile a percussione per anelli di tenuta e guarnizioni

- Semplifica l'inserimento di anelli di supporto esterni per cuscinetti obliqui
- Asse, sede dei cuscinetti e anelli di tenuta non vengono danneggiati
- Ghiera regolabile in 3 posizioni
- Impugnatura in acciaio



CODICE	CAPACITÀ (MM)	LUNGHEZZA
U04680150	9,5÷50	130
U04680151	18÷90	145

~~€ 83,00~~

**€ 58,00**

~~€ 104,00~~

**€ 73,00**

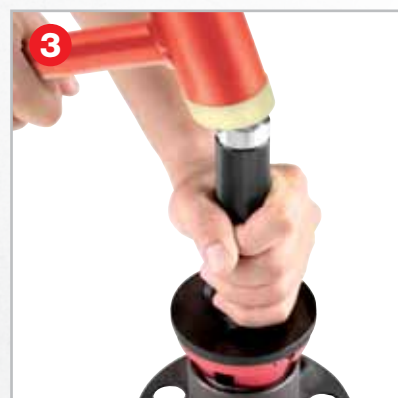
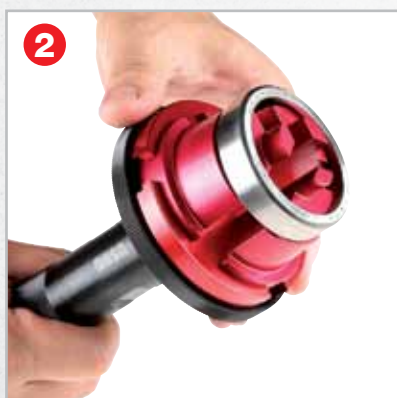



Inquadra il codice QR  
o vai sul canale YouTube USAG  
per guardare il video dimostrativo



## 1620 A

Cod. U16200001

12 V

### Tester candele preriscaldamento

- Utilizzabile con batterie 12V
- Rapido e preciso test delle candele di preriscaldamento
- Possibilità di test per ogni singola candela
- Adatto a tutti i tipi di candele da 3,5 a 12 Volt
- Adatto alle candele in acciaio e in ceramica
- Protetto contro il cortocircuito e inversione di polarità
- Struttura compatta ed antiurto



3,5÷12 V

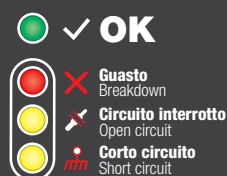

€ 202,00 **€ 141,00**



## 1612 A

Cod. U16120005

12 V 24 V

### Salva memorie 12 e 24V

- Utilizzabile con batterie 12V e 24V
- Evita la perdita dei dati degli accessori elettronici qualora si sostituisca la batteria o avvenga un'interruzione momentanea della corrente del veicolo
- Protetto contro il cortocircuito e inversione di polarità
- Segnalazione funzionamento con 2 LED luminosi
- Struttura compatta ed antiurto

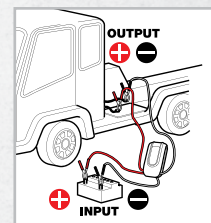
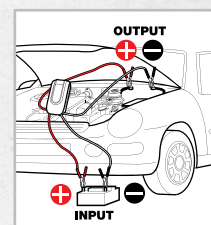

€ 143,00 **€ 100,00**



## 1612 BA12

Cod. U16120006

12 V

### Proteggi centraline 12 V

- Utilizzabile con batterie 12V
- Protegge le centraline durante le operazioni di saldatura, avviamento con caricatori o avviatori, avviamento con cavi
- Protetto contro il cortocircuito
- Segnalazione funzionamento con LED luminoso
- Struttura compatta ed antiurto

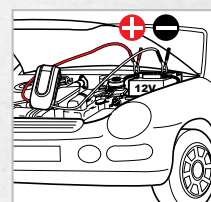

€ 71,00 **€ 49,50**

## 1612 BA24

Cod. U16120007

24 V

### Proteggi centraline 24 V

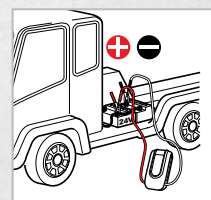

€ 71,00 **€ 49,50**



Kg	16 Kg	mm	L. 450
			H. 390
			P. 130



**3500 A**



**BATTERIE AGM  
(ABSORBED GLASS MAT)**

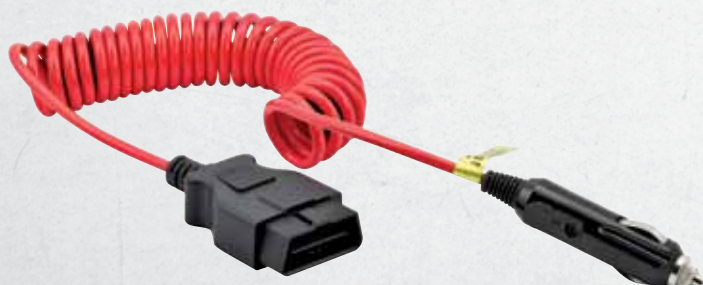

## 1613 AB12

Cod. U16130009

12 V

1200 A

### Avviatore portatile 12V

- Per avviamento di soccorso, come caricabatterie e come fonte di energia supplementare per veicoli (salvamemorie) e per apparecchi elettrici 12V
- Scocca antiurto in ABS
- Protezione da sovratensione
- Idoneo anche per batterie sigillate
- Pinze inclinate
- Fornito con caricatore di rete e cavo per presa accendisigari

€ 470,00

**€ 329,00**



**Lunghezza cavi  
155 cm**

## 1613 OBD

Cod. U16130003

### Cavo OBD salva-memorie 12 V

- Funziona collegato ad un avviatore 12V tramite attacco accendisigari
- Si collega al veicolo con connettore OBD (ingresso diagnosi)
- Compatibile con tutte le connessioni E-OBD e OBD-II
- Collegandolo all'interno dell'abitacolo permette di lavorare comodamente con il veicolo sul ponte sollevatore
- Fusibile di protezione integrato
- Lunghezza cavo: 2 metri

~~€ 44,90~~

**€ 31,40**





Kg	15 Kg	mm	L. 750
			H. 300
			P. 150



#### CARATTERISTICHE TECNICHE

Estensione min-max corpo	657÷887 mm
Estensione min-max bracci laterali	322÷566 mm
Estensione min-max corpo + bracci laterali	657÷1170 mm
Corsa base di supporto motore	0÷190 mm

## 1954 A

Cod. U19540001

**400**  
KG

### Supporto motore telescopico con bracci rotanti

- Sostiene il motore dal basso
- Permette di lavorare sul motore senza utilizzare cavi o sollevatori per trasmissione
- Dotato di 2 ganci di attacco scorrevoli per adattarsi ai sottoscocca di tutti i veicoli
- Braccio telescopico allungabile di 230 mm
- Movimento dei bracci con una copertura di 360°
- Due piedini di appoggio regolabili in altezza con parte di appoggio ricoperta in poliuretano
- Piede di supporto regolabile in altezza con regolazione di 8° in grado di regolarsi alla superficie di contatto

~~€ 563,00~~ **€ 394,00**

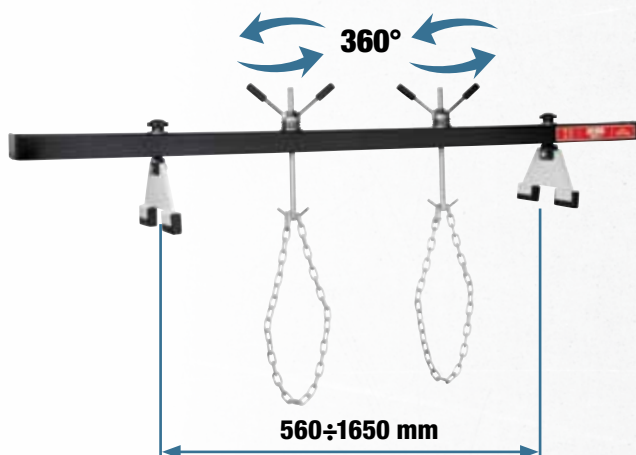

Kg	16 Kg	mm	L. 1650
			H. 65
			P. 50

## 1954 B

Cod. U19540002

**500**  
KG

### Barra sostegno motore

- Sostiene il motore dall'alto
- Permette di sostenere il motore durante lo smontaggio dei suoi supporti dal veicolo
- Ideale per interventi sul cambio, frizione, distribuzione, sostituzione supporti, paraoli motore e riparazione parti di carrozzeria

~~€ 216,00~~ **€ 151,00**



## 1955 A

Cod. U19550001

**600**  
KG

### Carrello per movimentazione veicoli

- Permette di facilitare lo spostamento di veicoli danneggiati o bloccati
- L'utilizzo di quattro carrelli consente un posizionamento e manovra a piacere della vettura
- Comando del cilindro idraulico tramite pedale
- Rulli scorrevoli in alluminio
- 4 ruote pivotanti bimateriali

~~€ 251,00~~ **€ 189,00**



**Facilmente trasportabile**

CE 2006/42/CE  
EN1494+A1

## 2510 C

Cod. U25100005

### Sollevatore idraulico 2t compatto

- Conformità alla Direttiva Macchine 2006/42/CE
- Modello compatto e leggero
- Impugnatura telescopica abbattibile: diventa una maniglia per il trasporto
- Ripiegando l'impugnatura è possibile trasportarlo come un trolley
- Valvola di sicurezza anti-abbassamento fuori dal controllo dell'operatore
- Regolazione della velocità di discesa
- Piattello rivestito in poliuretano
- Ruote in poliammide

**2**  
TON

~~€ 433,00~~ **€ 303,00**

#### CARATTERISTICHE TECNICHE

Portata	2 t
Alzata max	410 mm
Alzata min	95 mm

Kg	mm	L. 616
		H. 140
		P. 197

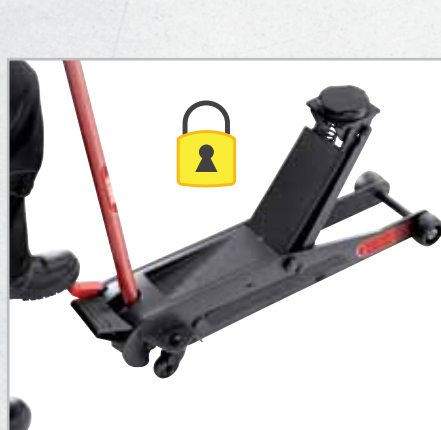

**Blocco di sicurezza a 320 mm**

CE 2006/42/CE  
EN1494+A1

## 2510 S

Cod. U25100006

### Sollevatore idraulico 2t con sistema di sicurezza

- Conformità alla Direttiva Macchine 2006/42/CE
- Dispositivo di blocco meccanico del piattello ad un'altezza di 320 mm
- Valvola di sicurezza anti-abbassamento fuori dal controllo dell'operatore
- Regolazione della velocità di discesa
- Pedale di avvicinamento rapido
- Piattello rivestito in poliuretano
- Ruote in poliammide

**2**  
TON

~~€ 448,00~~ **€ 313,00**

#### CARATTERISTICHE TECNICHE

Portata	2 t
Alzata max	470 mm
Alzata min	95 mm

Kg	mm	L. 905
		H. 135
		P. 240





**237 FB 1/2"**  
Cod. U02370070

**72**  
DENTI

### Cricchetto telescopico con testa snodata

- Modello a 72 denti con angolo di ripresa di 5°.
- Sistema di inversione con leva integrata.
- Meccanismo sigillato.
- Pulsante di rilascio della bussola.
- Impugnatura bimateriale conica.
- Asola di aggancio sull'impugnatura.



**+70%**

### Allungabile fino al 70% in più di un cricchetto standard

Il cricchetto telescopico 237 FB, permette di avere un braccio di leva maggiore rispetto ad un cricchetto tradizionale. Grazie alla testa snodata è possibile lavorare anche in punti con scarsa accessibilità.

Pulsante di sgancio e testa sigillata



~~€ 85,00~~

**€ 59,50**



Testa snodata a 180°



7 posizioni di allungamento

**831 A**

Cod. U08310001

### Goniometro digitale

- Permette serraggi angolari di precisione digitale in totale semplicità
- Per serraggi destrorsi e sinistrorsi
- Scala: 0÷360° con risoluzione 0,1°
- Doppia indicazione: luminosa (LED) e sonora (buzzer) al raggiungimento del valore impostato
- 9 valori di angolo obiettivo preimpostabili
- 50 misurazioni memorizzabili
- Fornito in custodia di ABS con certificato di taratura
- Alimentazione: 2 batterie AAA (incluse nella confezione)



~~€ 159,00~~

**€ 100,00**

**2800 S21**

Cod. U28000085

**21**  
PEZZI

### Kit di 21 utensili per pistoncini freni

- Assortimento per comprimere e ruotare i pistoncini dei freni a disco anteriori e posteriori
- Permette di riposizionare agevolmente i pistoncini del freno nell'alloggiamento della pinza
- Include 2 mandrini con rotazione destra e sinistra e da diverse piastre, adattatori e accessori
- Compatibile con i seguenti modelli d'auto: CITROEN, AUDI, FIAT/ALFA ROMEO, FORD, ISUZU, HONDA, JAGUAR, BMW, MERCEDES, MITSUBISHI, NISSAN, ROVER, TOYOTA, VOLVO, VOLKSWAGEN, MAZDA, SAAB, GM, SUBARU, PEUGEOT, RENAULT, MINI, OPEL
- Fornito in cassetta di plastica



~~€ 147,00~~

**€ 103,00**

# Nuova App per tablet iOS e Android!

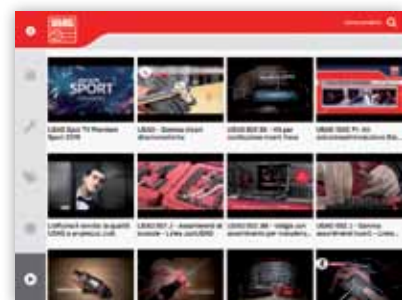
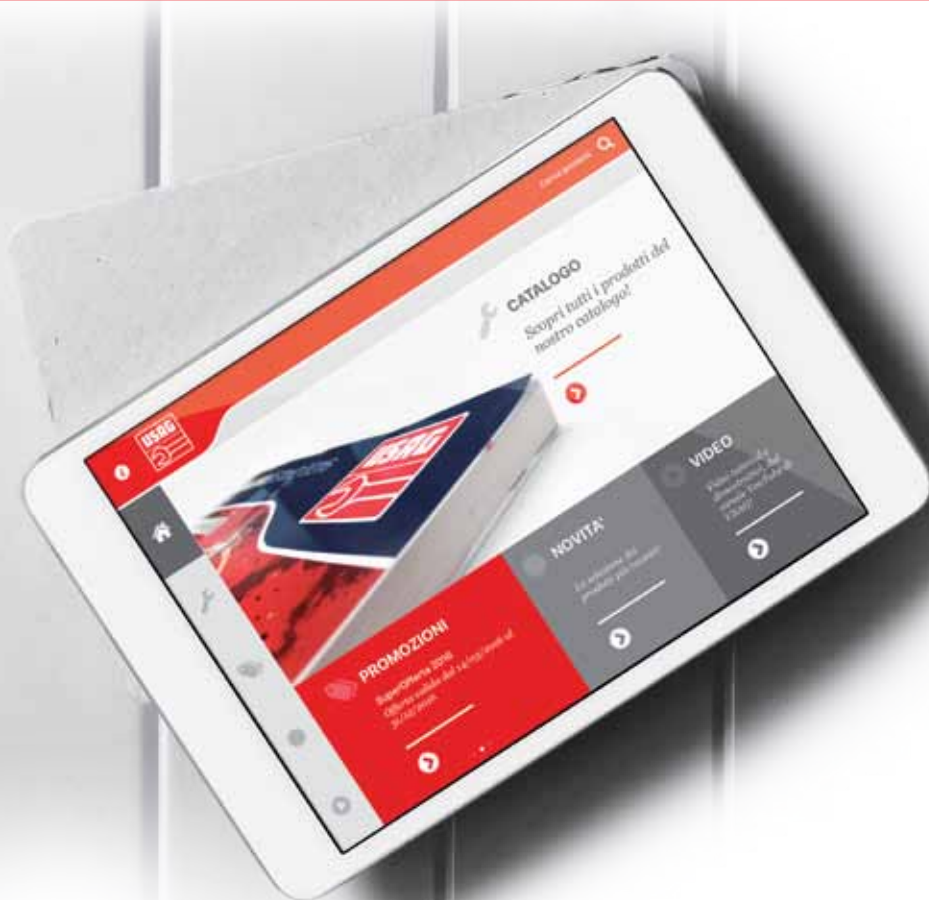

Totalmente riprogettata per offrire un'esperienza davvero performante, permette di racchiudere l'intero scibile del Catalogo USAG in un dispositivo più piccolo di un libro!

Offerta valida fino al 31 Agosto 2017, salvo esaurimento scorte. Tutti i prezzi sono da intendersi in Euro, IVA esclusa.  
Le immagini riprodotte in questa brochure sono indicative.  
Stanley Black & Decker Italia S.r.l. si riserva in ogni momento di modificare le caratteristiche tecniche dei prodotti.



**Stanley Black & Decker Italia S.r.l.**  
Via Volta, 3 - 21020 Monvalle (VA)  
Tel. +39 0332 790111  
Fax +39 0332 790330  
info.mv@usag.it

**usag.it**

Seguici anche su:

